

**First research report for the European Trade Union Confederation
(ETUC)**

Study on the safety of loft ladders and ladder foots

As part of the implementation of ETUC STAND, the ETUC Standardisation project (Work Programme 2022)

PROSIBAU Helmus Kelm Meins-Becker GbR
Contact: Prof. Dr.-Ing. Manfred Helmus

August-Thewes Weg 12
42781 Haan

Date, 19.12.2022, Haan
location:

Publisher



European Trade Union Confederation (ETUC)

The European Trade Union Confederation speaks with a single voice on behalf of European workers to have a stronger say in EU decision-making. It represents 45 million members from 93 trade union organisations in 41 European countries, plus 10 European Trade Union Federations.

The ETUC aims to ensure that the EU is not just a single market for goods and services, but is also a Social Europe, where improving the wellbeing of workers and their families is an equally important priority. The ETUC standardisation project (ETUC STAND) aims at ensuring sustaining and reinforcing trade union representation and their effective participation in the development of standards. It crystallises its long-held demand that standards should ensure the highest quality of working conditions, including among other things a high level of public and occupational health and safety across Europe. Moreover, the ETUC insists on the autonomy of the social partners - standards should not encroach upon the autonomy of social partners.

E-mail: standards@etuc.org

 [@ETUC_standards](https://twitter.com/ETUC_standards)

www.etuc.org/en/issue/standardisation

Author



PROSIBAU was founded in 2011 and has been dealing with the transformation of the construction and real estate industry for over 10 years. The research focuses on process management, and the digital transformation. PROSIBAU also offers extensive experience in the field of occupational safety, carrying out several research projects surrounding the integration of radio-frequency-identification (RFID) into personal protection gear, as well as the implementation of Building-Information-Modeling with the purpose of improving occupational safety. Clients include both private companies, such as planners, and builders, as well as public institutions, e.g. municipalities, and funding bodies such as the Federal Office for Building and Regional Planning.

E-mail: kelm@prosibau.de www.prosibau.de/

With the financial support of the European Commission and EFTA



Executive summary

This research presents the results of a study that was commissioned by the ETUC in 2022 in order to examine window-cleaning ladders and loft ladders with regard to their safety.

Literature research carried out in the course of the report has shown that accident occurrences in the area of fall accidents continue to be high and that costs amounting to billions are incurred annually for insurance carriers. Fatal accidents with high consequential costs are even possible in cases of falls from low heights. The sometimes high divergence of accident figures within the EU shows that different levels of importance are attached to safe handling at work.

In the case of shortening ladder stabilisers, a reduction in stability can be confirmed. The loss of stability is linear and, depending on the boundary conditions, ranges around 0.36% per centimetre of reduced stabiliser length. It has also been shown that the overall stability depends on many other boundary conditions. Friction, person weight's, set-up angle and surface roughness could be explicitly identified as the most significant influencing variables. It is also found that, in addition to the percentage reduction due to the shortening of the stabiliser, the overturning moment can be very low under certain circumstances, if the other variables are unfavourable. A situational and individual examination of the circumstances is therefore always recommended to assess whether the use of a ladder is justifiable. In general and to ensure safety, it is recommended that the maximum standing height be limited when shortening the truss. Furthermore, stabilisation by another worker at the foot of the ladder is possible in critical cases. The use of materials with higher coefficients of friction at the head of the ladder can be another option to increase stability. The underlying test procedures for approval of the ladders should be extended to include dynamic forces. Attention should also be paid to the overturning moment, which could be tested likewise.

In the case of the loft ladder, a wooden stair was examined. The testing of the release torques showed that humidity has a considerable influence on the loosening of the screw connections. Due to the shrinkage and swelling of the wood, the release torques can change considerably, both positively and negatively. It is precisely here that the use of locking devices to prevent screws from loosening is recommended. Spring washers, serrated and toothed washers, disc springs or tension washers are cost-effective and simple ways to significantly reduce screw loosening. Special adhesives or pre-treated screws are another option for durable connections. Furthermore, an inclusion of loft ladders in the EU Construction Products Regulation is an additional measure to increase the underlying safety requirements and also to implement them in the long term. Installation by specialist contractors or a regular maintenance by professional groups could also be done. The existing test procedures should be expanded to include a Junker test (vibration test) in order to prove the permanent reliability of the connections used. This way, it can be ensured that adequate connections are used.

Table of Contents

EXECUTIVE SUMMARY	3
TABLE OF CONTENTS	4
ILLUSTRATION	6
LIST OF TABLES	8
1 INTRODUCTION AND ASSIGNMENT.....	1
1.1 INITIAL SITUATION	1
1.2 OBJECTIVE	2
1.3 LIMITATION OF THE STUDY	2
1.4 PARTNER	3
2 OUTLINE OF THE RESEARCH PROJECT.....	3
2.1 WORK PACKAGE A	3
2.2 WORK PACKAGE B.....	4
2.3 WORK PACKAGE C.....	4
3 (WORK PACKAGE A) - PRELIMINARY STUDY ON ACCIDENT DATA	5
3.1 NATIONAL DATA.....	10
3.1.1 GERMANY.....	10
3.1.2 GREAT BRITAIN	12
3.1.3 POLAND	14
3.1.4 SWITZERLAND	15
3.2 ANALYSIS AND PERSPECTIVE.....	17
4 THEORETICAL RESEARCH FRAMEWORK.....	18
4.1 DEFINITION OF RESEARCH SUBJECTS.....	18
4.1.1 WINDOW-CLEANING LADDERS	18
4.1.2 LOFT LADDERS.....	22
5 (WORK PACKAGE B) - EXPERIMENTAL SETUP AND RESULTS	24
5.1 METHODIC PROCEDURE RESEARCH SUBJECT A.....	24
5.2 METHODIC PROCEDURE RESEARCH SUBJECT B.....	26
5.2.1 RESULTS	28
5.2.2 TEST EXECUTION SUBJECT A.....	33

5.3	METHODIC PROCEDURE RESEARCH SUBJECT B	36
5.3.1	TEST EXECUTION SUBJECT B	40
5.3.2	RESULTS	42
6	<u>(WORK PACKAGE C) – RECOMMENDATION FOR ACTION</u>	45
6.1	ANALYSIS OF THE RESULTS SUBJECT A	45
6.1.1	RECOMMENDATION	45
6.2	ANALYSIS OF THE RESULTS SUBJECT B	47
6.2.1	RECOMMENDATION	48
	<u>APPENDIX</u>	50
	<u>BIBLIOGRAPHY</u>	51
	<u>PUBLICATION BIBLIOGRAPHY</u>	51

Illustration

Figure 1: Partners of the study	3
Figure 2: Development of occupational accidents in selected countries of the European Union (economic sectors A_C-N)	5
Figure 3: Development of occupational accidents in the European Union	6
Figure 4: Development of occupational accidents by duration of absence.....	7
Figure 5: Cartographic representation of the distribution of occupational accidents by incidence (2018)	7
Figure 6: Development of the absolute number of deaths within the EU	8
Figure 7: Incidence rates of selected European countries, deaths per 100,000 population	8
Figure 8: Distribution of death incidence rates within the European Union incl. Great Britain (2019)	9
Figure 9: Development of ladder and stair accidents 2010-2020 in Germany, (all professions)	11
Figure 10: Percentage change in fall accidents by age	12
Figure 11: Development of occupational accidents in Great Britain	12
Figure 12: Percentages of the type for non-fatal occupational accidents in Great Britain	13
Figure 13: Development of prohibition and improvement notices.....	13
Figure 14: Distribution of occupational accident incidence rates by area in Poland.....	14
Figure 15: Age composition of employees in occupational accidents	14
Figure 16: Development of occupational accidents due to falls and falls from heights in Poland 2011-2019	15
Figure 17: Development of occupational accidents involving stairs	15
Figure 18: Development of occupational accidents due to slips and falls	16
Figure 19: Types of extension ladders.....	19
Figure 20: Illustration of a sliding/folding loft ladder.....	23
Figure 21: Window-cleaning ladder.....	25
Figure 22: Rung rope ladder	25
Figure 23: Schematic representation of the experimental set-up	27
Figure 24: Forces and variables involving the calculations.....	28
Figure 25: Graphical representation of the correlation of the tilting force [N] to the stabiliser length.....	29
Figure 26: Comparison of the calculated overturning forces with and without consideration of static friction forces, orange: without static friction, blue: with static friction	30
Figure 27: Comparison of the changed parameters, orange: 1500N, blue: 650N	31
Figure 28: Overall comparison of the test objects [N]	32
Figure 29: Experimental set-up	33
Figure 30: Test weight on the ladder.....	33
Figure 31: Marked stabiliser	33
Figure 32: Graphical representation of the tilting force as a function of the stabiliser length	34
Figure 33: Comparison of calculations and carried out testing [N]	35
Figure 34: Comparison of adjusted calculations and carried out testing [N].....	35
Figure 35: Causes of unfastening and failure of bolted joints	36

Figure 36: Maximum change in length due to contraction and shrinkage	37
Figure 37: Marking the screws for observation purposes	39
Figure 38: Loft ladder system preassembled, screws to be installed are marked	40
Figure 39: M6 x 25 Phillips screw, half round head	40
Figure 40: Section of the assembly instructions, position 49	41
Figure 41: Climate chamber of the Haan Occupational Safety and Health Centre	42
Figure 42: overview of the tested screwed joints	43
Figure 43: Forgetfulness curve after Ebbinghaus	46
Figure 44: Example of a screw connection of a drive-in nut in wood.....	47

List of tables

Table 1: Ladder accidents by injured body part, 2010-2020.....	11
Table 2: Functional dimensions for rung ladders	18
Table 3: Summary of test procedures for single ladders according to EN 131-2	20
Table 4: Functional dimensions of loft ladder systems	22
Table 5: Testing method for loft ladder systems according to EN14975:2006+A1:2010	23
Table 6: Properties of the testing subjects	25
Table 7: New parameters including consideration of static friction force.....	30
Table 8: Adjusted parameters	31
Table 9: Results of the test under real boundary conditions.....	34
Table 10: Release torques of the self-assembled and manufacturer-assembled screws	41
Table 11: Release torques for the screwed connections after the test cycle.....	42

1 Introduction and assignment

1.1 Initial Situation

International and European standards play a growing role not only in the economy, but also in the organisation of production and working conditions. For example, working equipment complying with good standards can improve safe working conditions. European standards can help to achieve upwards convergence, meaning that workers in countries with lower requirements and/or weak legislation would benefit from a better standard. Therefore, the European Trade Union Confederation launched the ETUC STAND project¹, which is aimed at sustaining and reinforcing trade union representation and effective participation in European standardisation. The project runs since 2015 with the financial support of the European Commission and the European Free Trade Association (EFTA). One of the many aspects the ETUC is working on is occupational health and safety. Prevention of risks is key. Over many years, the ETUC has been very active in driving prevention measures. Unions make workplaces safer and union action to promote improvement in Health and Safety rules is crucial.

Ladders are an indispensable tool that is used both in private everyday life and also at work. The variety of materials used to manufacture ladders is diverse. At work, ladders are often used by workers in the construction sector, agriculture and in the cleaning industry. However, working on ladders involves many risks, as they are carried out at considerable heights. Fall accidents often have dramatic consequences. The financial costs associated with fall injuries are significant. Injuries range from broken arms and legs to fractures and even death. This can lead to lifelong problems such as disability but also the payment of medical treatment and accident compensations to the employees or their families they may leave behind. While ladders are indispensable for the worker to get from one place to another, they are not suitable as a workplace. Yet, workers spend many hours working on the ladder and lifting heavy weight. There are a number of measures to prevent falls and other accidents when working with ladders. For instance, the quality, ergonomics and safety of ladders can help to limit or even prevent accidents. The design of ladders, but also the durability, ease of use and robustness can contribute a good, safe and practice-oriented work equipment.

In the course of this study, two different ladder systems are examined with regard to their safety. These are, on the one hand, loft ladders and, on the other hand, window-cleaning ladders. The ETUC report on accidents with loft ladders used by chimney sweeps² describes accidents of chimney sweeps using loft ladders. The aim of the first part of this study was therefore to test loft ladders, covering temperature testing, humidity and mixture of materials (e.g. wooden ladder with metal screws). The outcome of the tests were analysed and recommendations were provided.

¹ etuc.org 2022, retrieved: 13.08.2022.

² ETUC.

The second research object are window-cleaning ladders. These are often supported by a ladder foot to increase stability, especially for ladders which are reaching high. The modification of the size of the ladder foot and the resulting stability of the ladder were investigated.

1.2 Objective

There are a number of measures to prevent falls and other accidents when working with ladders. For instance, the quality, ergonomics and safety of ladders can help to limit or even prevent accidents. The design of ladders, but also the durability, ease of use and robustness can contribute to a good, safe and practice-oriented work equipment. Loft ladders are used by a range of craftsmen such as chimney sweeps, carpenters and electricians. The loft ladders are installed in a building usually at the time of construction and remain there for many decades without being checked for their stability and robustness. Due to the high temperature differences, the components are subjected to high stress. It must be investigated whether this can lead to failure relevant to safety. Also, material fatigue may be caused by ageing, considering the loft ladders remain in their place for a long time. Fatigue can result in the dissolving of anchorages. The first objective of the study is therefore to test the durability, robustness and safety for use of different materials of loft ladders, focusing also on different material for ladder parts (e.g. wooden ladder with metal screws). The study investigates in solutions and recommendations to make the loft ladder more robust and hence safer to use. The focus is on the manufacturing of the ladder. The study also undertook a temperature test and check different test loads. Furthermore, the second objective is to test a modification of size of the ladder foot and the resulting stability of window-cleaning-ladders under different loads. The test took the typical use of a window-cleaner into account but the results of this test should also be applicable to similar ladder types.

By conducting a study focusing on the testing conditions of loft ladders and the ladder foot of window-cleaning ladders, the objectives are:

- to collect accident data to assess the relevance of the study
- to inform about the testing results for loft ladders / ladder feet with a view to improve overall stability and robustness.
- to provide recommendations for manufacturers and for standard-writers in CEN/TC 93 'Ladders' with view to increase safety when working with ladders through good design and manufacturing.

Accident data for loft ladders and window-cleaning ladders in Europe was collected with view to analyse the sources and technical shortcomings that cause occupational accidents. The stability and safety of loft ladders was tested and modification of length of the ladder foot by ladders particular window-cleaning ladders.

1.3 Limitation of the study

This research report shows the relevance of accidents at work with ladders and stairs by comparing accident data in the European area. By testing the tipping stability of window-cleaning ladders and checking the stability of screw connections on loft ladders, a recommendation for action is drawn up. The results show recommendations for increasing the safety of the two objects of investigation.

1.4 Partner

The ETUC, as the client of this study, determined the content and the basic conditions for carrying out this study in close coordination with PROSIBAU Helmus Kelm Meins-Becker GbR, which is responsible for the scientific evaluation. The testing is being carried out with the support of the Haan Occupational Safety and Health Centre, Germany.



ETUC



ProsiBau



Haan Occupational Safety
and Health Centre

Figure 1: Partners of the study

2 Outline of the research project

The work packages are divided into 3 parts. After the kick-off meeting to discuss the different steps of the study, first accident data for loft ladders and window-cleaning ladders in Europe was collected and curated. The procedure and boundary conditions for the tests was also coordinated and defined. The second work package was the preparation of the interim report, followed by a second meeting to discuss the preliminary results of the testing and the report. After the first tests have been carried out and the necessary information has been collected from the statistics, the interim report was made available to the participants and the further procedure was discussed. After the completion of the experiments, the final report was completed in time for the deadline (01.11.2022). The research report concludes in a short, easy-to-understand summary. After submission, up to two further meetings were held with the relevant stakeholders of CEN/TC 93.

2.1 Work package A

After the relevant accident data had been determined in consultation with the ETUC, the boundary conditions of the tests were determined. Suitable laboratory and material tests are used to examine step by step how the dimensioning of ladder feet affects the stability of the ladder under various load scenarios. In the first scenario the appropriate ladder type was selected and typical load scenarios were defined in coordination with ETUC. By alternating the combination of different loads with ladder feet dimensions, the study examined whether the risk of the ladder tipping increases significantly as a result of reducing the ladder feet dimensions.

The second scenario deals with the material fatigue and wear of loft ladders. Therefore, the ladders were exposed to different environmental conditions that mimic the conditions of an attic. Both, high and low temperatures, as well as a corresponding alternating humidity were tested to determine which conditions are the most unfavourable for safe use. Likewise, the load cycles

were coordinated closely with the ETUC. The aim is to assess the safety risk of existing ladders by evaluating their screw connections and check for characteristics that lead to failure. While the work safety centre in Haan was responsible for carrying out the testing, the subcontractor executed the scientific support and evaluation and made a final recommendation.

2.2 Work Package B

Following work package A, work package B deals with the implementation and evaluation of the test results. The test results are summarised and evaluated in advance, so that they are discussed in an interim report. The interim report prepared in package B contains the initial results as well as relevant accident data. The data already collected and analysed offer the most meaningful trends, which correlate with the objective of the study and thus provide a first outlook on the final result. In the course of work package B, a second meeting took place to discuss the research results obtained so far and, if necessary, to adjust or to examine certain boundary conditions in more detail.

2.3 Work Package C

Work package C comprises the final consolidation of the information compiled in packages A and B and focuses on completing the final research report. Here, the recommended action for the further procedure of both research subjects is completed and the results are also presented in an executive summary.

3 (Work package A) - Preliminary study on accident data

Since 2008, the Member States of the European Union have been obliged to publish data on occupational accidents that have occurred in their country. This is based on the European Statistics on Accidents at Work, which defines the methodology for data collection.³ According to Article 2 Annex IV of Regulation (EC) No 1338/2008 of the European Parliament and of the Council, Member States are obliged to transmit their statistics accordingly. The indicators to be transmitted include:

- General information about the injured person
- Degree of injury and lost time in days
- Economic sector of the company
- Characteristics of the workplace
- Characteristics of the accident, cause and accompanying circumstances.⁴

An occupational accident is defined as "an event occurring during work or in the performance of a professional activity or during the period spent at work, which can be clearly delimited and which leads to physical or mental harm"⁵. This also includes accidents that do not occur within the first place of work, but also take place on the premises of another organisation. Accidents occurring during a business visit outside the company premises, as well as in public places or on means of transport, are also included. Displacement accidents, intentional self-inflicted injuries and accidents due to purely natural causes are not included. Only occupational accidents that result in more than three full calendar days of absence or death are considered. A complete overview of the variables and reporting requirements can be found in the European Statistics on Accidents at Work (ESAW) Regulation.

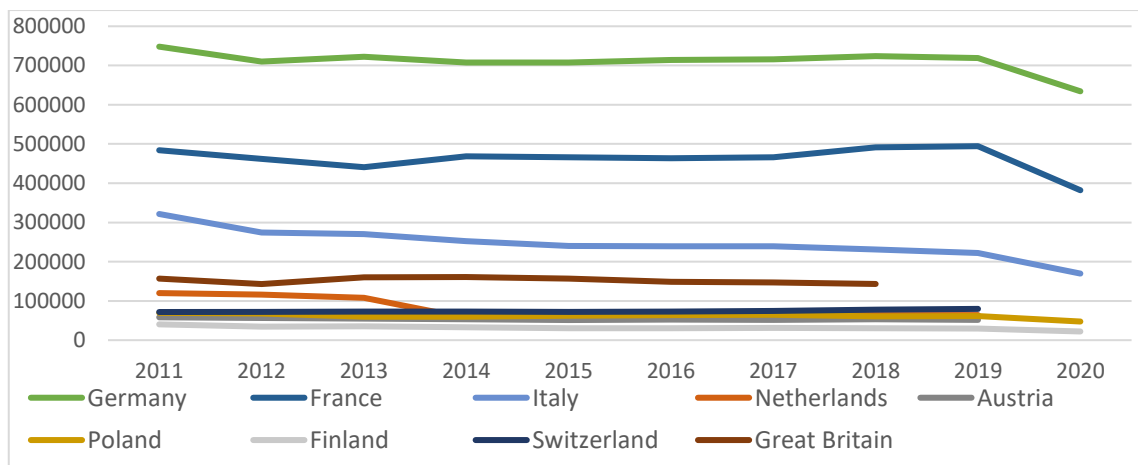

Figure 2: Development of occupational accidents in selected countries of the European Union (economic sectors A_C-N)⁶

³ European Statistics on Accidents at Work (ESAW) - Summary methodology - 2013 edition 2022.

⁴ Ibid.

⁵ Ibid.

⁶ Statistics | Eurostat 2022a.

Figure 2 shows the development of occupational accidents in selected European countries since 2011. The highest number of occupational accidents can be attributed to Germany as the most populous country in the European Union. Here, the rate remains constant at over 700,000 cases. Only in 2022 can a reduction to just under 630,000 be recorded. This decline can be attributed primarily to the SARS-CoV pandemic and the accompanying catalogue of government measures in all data sets. In France, a slight upward trend in occupational accidents can be seen since 2012; here, the number of occupational accidents was around 440,000 in 2013 and subsequently rose to 490,000 accidents. Italy, on the other hand, recorded a decline from 275,000 to around 220,000 in the same period. Apart from the Netherlands, where the numbers fell sharply between 2013 and 2014, the rise in the other countries shown remains constant and in the range of 30,000 to 80,000 accidents at work.

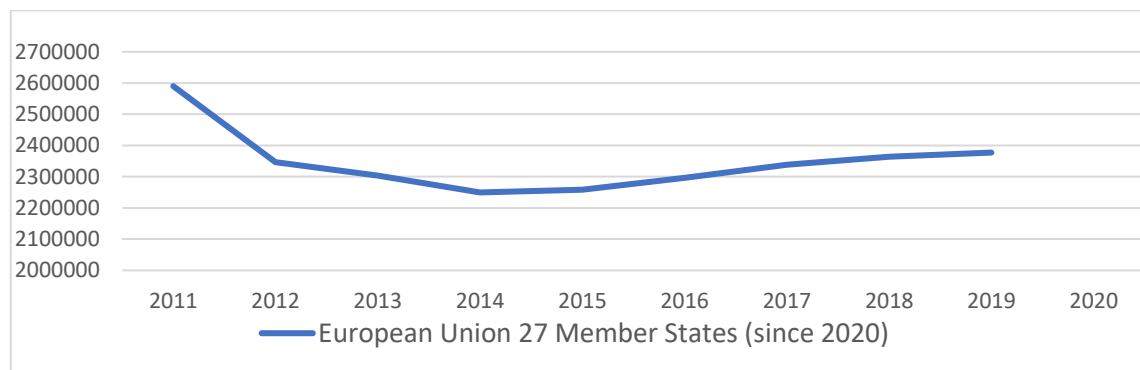

Figure 3: Development of occupational accidents in the European Union

The cumulative view of occupational accidents for the entire European Union (economic sectors A_C-N)⁷ shows a decline in the number of occupational accidents from 2011 to 2014 from 2.6 million to 2.2 million. From 2015, the number of occupational accidents rises steadily again to a value of 2.37 million. The development of occupational accidents by lost time can be seen in Figure 4. It is striking that the number of all occupational accidents up to a duration of 20 days ranges between 300,000 and 650,000. For a duration of absence of more than 4 days, i.e. also more than 20 days, the number in 2019 is approx. 2.3 million. This means that in approx. 980,000 cases, periods of absence of more than 20 days are the rule. This corresponds to a 40% share of the total number of accidents. Overall, the development of the duration of absences has been stable over the years. A slight increase can be detected around 2017.

⁷ Statistics | Eurostat 2022b.

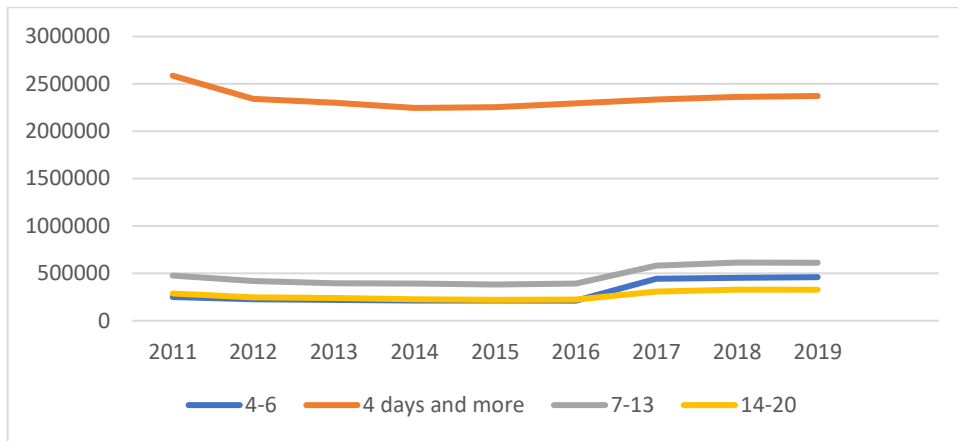

Figure 4: Development of occupational accidents by duration of absence

Looking at continental Europe (Figure 5), an accumulation of accidents at work can be seen in the south-west. In particular, France, Spain, Portugal and Switzerland stand out due to an increased number of incidence rate. These countries are also among the most densely populated. The more north-east one goes, the fewer occupational accidents are registered.

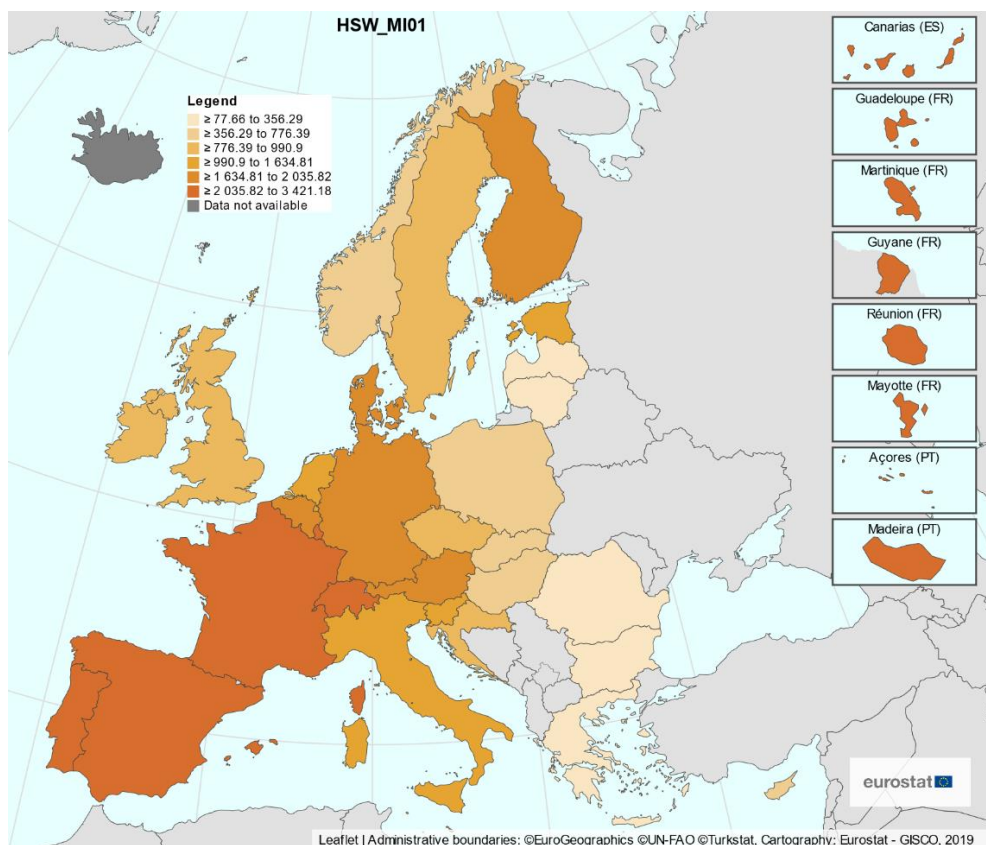

Figure 5: Cartographic representation of the distribution of occupational accidents by incidence (2018)⁸

⁸ Statistics | Eurostat 2022c.

Occupational accidents resulting in death

In addition to occupational accidents resulting in long periods of absence, fatalities can also occur. Again, based on the ESAW data, the economic sectors A_C-N [Agriculture; industry and construction (except mining)] are considered. Figure 6 shows that Italy and Germany have by far the most fatalities. Over the period 2011-2020, the numbers range between 510 and 349, with the periodic fluctuation remaining fairly even. This is also evident in the other countries considered. Only Poland records continuously decreasing numbers. The absolute numbers must be considered in relation to the population density. The entire European Union remains constant in the development of work-related deaths and falls slightly. Compared to 2011 with a total of 3519 fatalities, in 2019 there are still 3008 work-related fatalities. The exit of the United Kingdom does not seem to have a significant influence on the development.

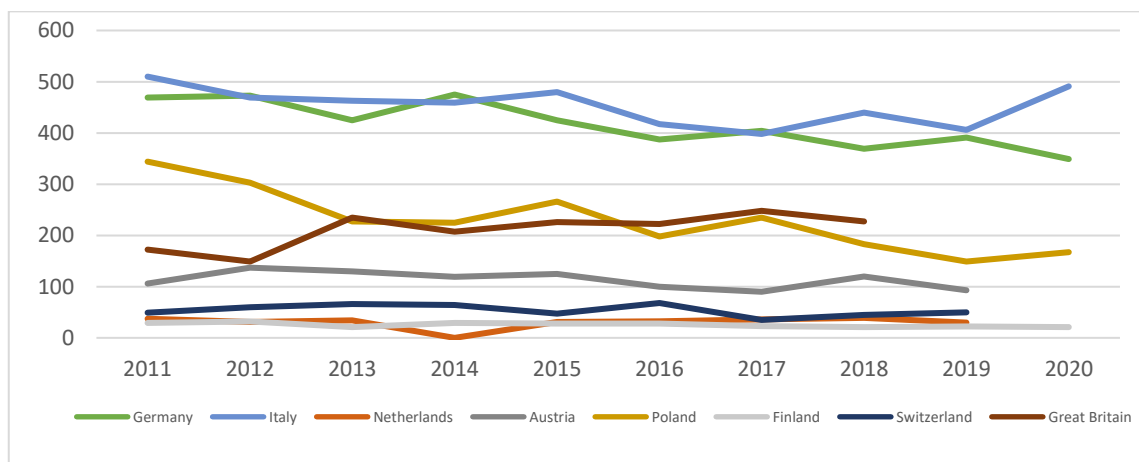

Figure 6: Development of the absolute number of deaths within the EU ⁹

Broken down by incidence, it can be seen that France, Italy and Austria in particular have above-average death incidence rates. All other countries considered are consistently below the EU average. Poland in particular stands out with the positive development of the incidence rate from 2.56 to 1.29. It should also be mentioned that Bulgaria has the highest value for occupational accidents with an incidence of 4.51 (2020). Sweden has the lowest value with 0.76 (2020).

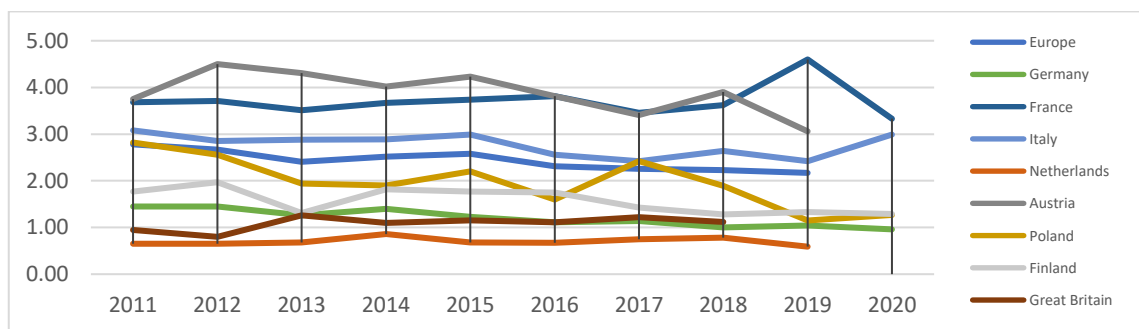

Figure 7: Incidence rates of selected European countries, deaths per 100,000 population ¹⁰

⁹ Statistics | Eurostat 2022e.

¹⁰ Statistics | Eurostat 2022e.

Overall, there is a clustering of deaths in the south and east of the European Union. Incidence rates are also higher in the south-west than in the northern part of the EU.

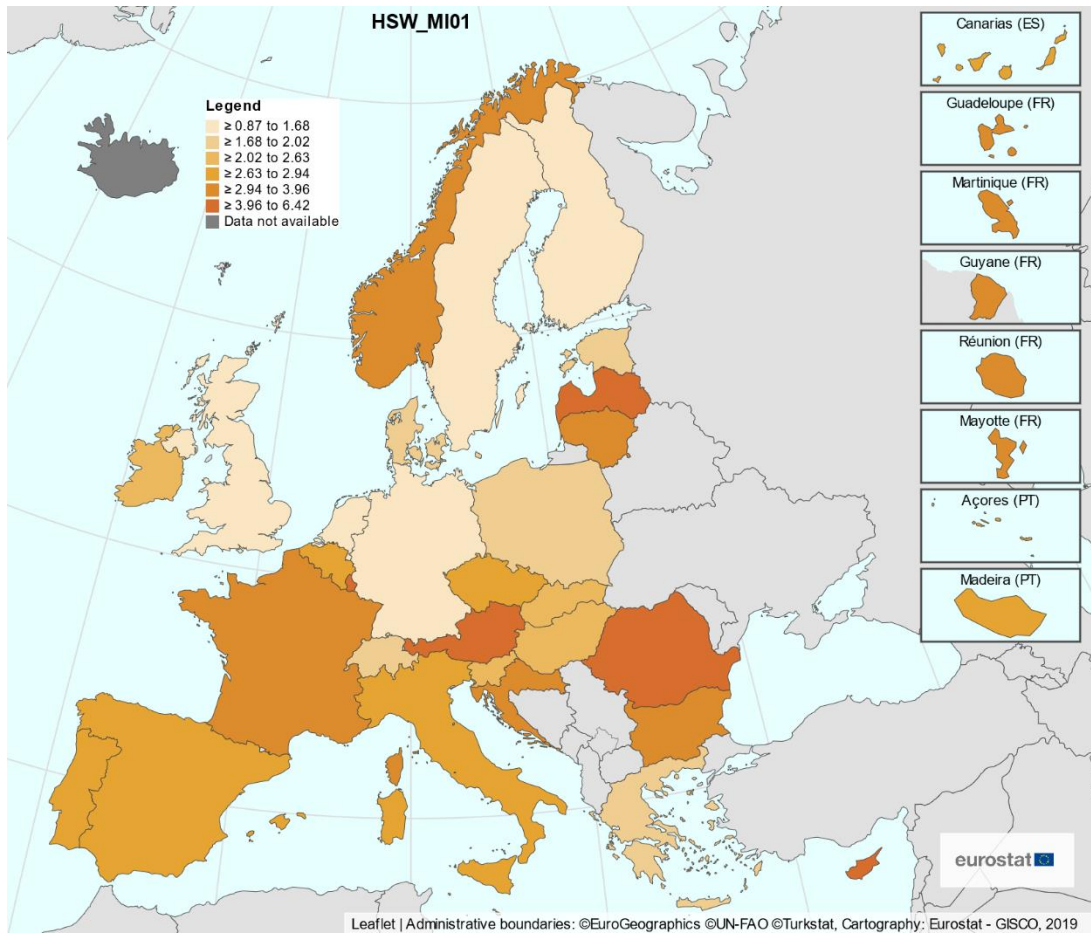

Figure 8: Distribution of death incidence rates within the European Union incl. Great Britain (2019) ¹¹

With a total of more than 2.3 million accidents at work, a large proportion of which result in absence from work for well over 4 days, this shows that there is still a need for action to further improve existing safety standards.

¹¹ Statistics | Eurostat 2022d.

3.1 National data

In addition to accessing the accident data published by the ESAW, some countries offer the possibility of obtaining a more detailed breakdown of accident data via the statutory accident insurance funds or other sources. In the following, the accident data of selected countries are examined in more detail and explained in direct reference to fall accidents, especially with ladders and stairs.

3.1.1 Germany

According to an evaluation by the BG Bau, "accidents involving ladders [...] account for almost 50% of fall accidents among insured persons of the BG BAU"¹². In the period from 2009 to 2018, BG Bau registered more than one third of the total of 871 fatal occupational accidents as fall accidents. This is the most common cause of death in occupational accidents during construction work.¹³

The German Social Accident Insurance (DGUV) documents annually the general statistics for accident data with and without fatal consequences in order to get a picture of the status and development of accidents.¹⁴ The data are divided into extensive areas, such as the distribution of occupational accidents in the company according to main occupational groups or objects of the accident black spots. Stairs play a significant role in this with 42,399 and 20,953 reportable accidents (2020).¹⁵ Most accidents (approx. 24.6 %) occur in the commercial or industrial sector. Other areas where accidents also occur are administrative buildings (13.7 %), health care facilities (13.7 & %), public buildings (12.4 %), recreational facilities (11.5 %), construction sites (9.9 %), educational facilities (5.2 %), and home areas (5.8 %).¹⁶

The most frequent consequences of a ladder accident in the last 10 years can be seen in Table 1. The lower extremities are particularly affected. Fatalities are mainly caused by head injuries or complications in multiple areas. Falls from low heights are also associated with considerable risks. Almost half of the fatal accidents occur at a height of less than 5 metres.¹⁷

¹² Dipl.-Ing. Hendrikje Rahming 2018.

¹³ baa.de 2022.

¹⁴ Deutsche Gesetzliche Unfallversicherung e.V. 2010-2020, p. 6.

¹⁵ Deutsche Gesetzliche Unfallversicherung e.V. 2020, p. 63.

¹⁶ Deutsche Gesetzliche Unfallversicherung e.V. 2010, pp. 45–50.

¹⁷ baa.de 2022.

Table 1: Ladder accidents by injured body part, 2010-2020¹⁸

Injured bodypart	Reported accidents		Fatal accidents	
		%		%
Head	16094	6.2%	81	59.6%
Neck, spine	22274	8.5%	10	7.4%
Trunk (chest, abdomen, organs)	30417	11.7%	13	9.6%
Upper extremities	77191	29.6%	2	1.5%
Lower extremities	111578	42.8%	4	2.9%
Entire human (multiple areas)	523	0.2%	26	19.1%
Not specified	1887	0.7%	0	0.0%
In total	260667	100	136	100

The development of portable ladder and staircase accidents shows a slight downward trend in the case of ladder accidents. Here, accidents fall from 26,159 in 2010 to 20,953 in 2020. In the case of reportable accidents involving stairs, no precise trend can be observed. Here, the development stagnates on average at approx. 44,000 accidents per year.

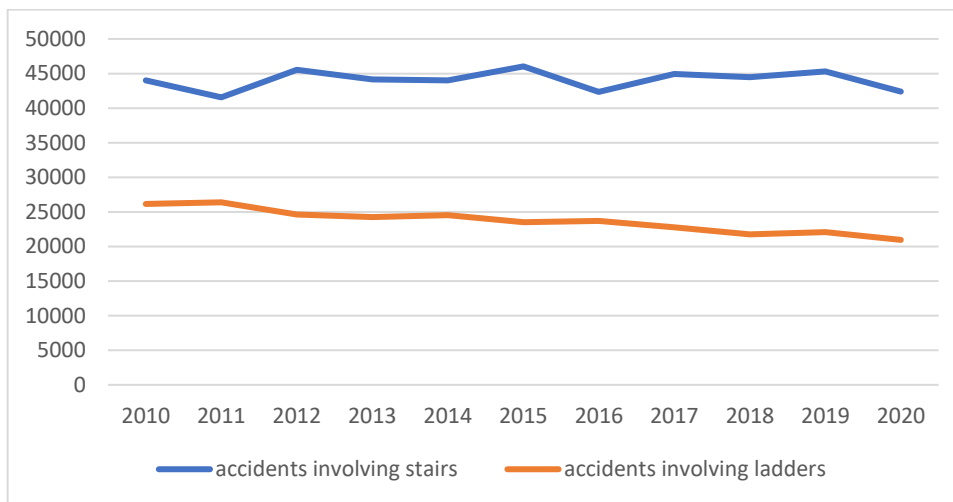

Figure 9: Development of ladder and stair accidents 2010-2020 in Germany, (all professions)¹⁹

The age of the employees can be used as a further criterion. A significantly higher incidence of fall accidents can be seen especially in the age group of 50 to 60 years. The number of fatalities is also significantly higher in the 55 to 59 age group than in other age groups. In relation to demographic change and the associated ageing of society, this can lead to an increase in accidents in the older age groups.

¹⁸ Deutsche Gesetzliche Unfallversicherung e.V. 2010-2020.

¹⁹ Deutsche Gesetzliche Unfallversicherung e.V. 2010-2020.

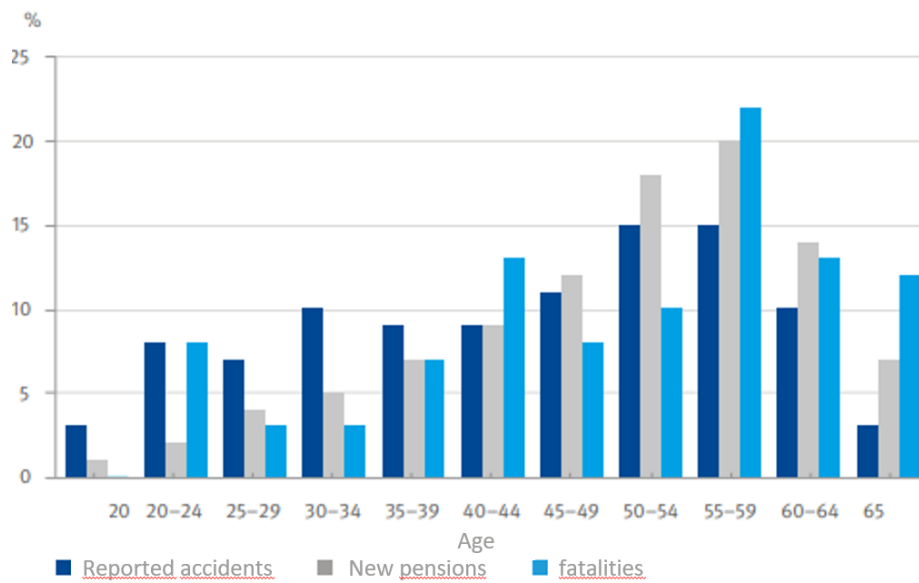

Figure 10: Percentage change in fall accidents by age²⁰

Overall, it shows that the number of fall accidents with ladders and stairs in Germany is constant, with a slight downward trend.

3.1.2 Great Britain

The UK collects occupational accident data in the construction industry through the Health and Safety Executive (HSE). Accidents at work in the construction industry have a slight downward trend in recent years. In 2017, the incidence rate for fatalities in the UK was 1.37; in 2020, it is 1.62 per 100,000 inhabitants.

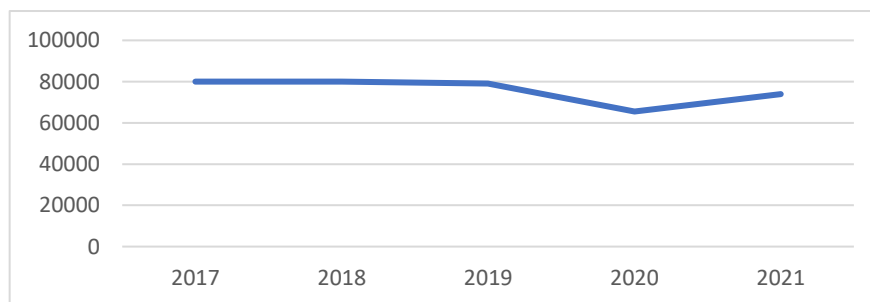

Figure 11: Development of occupational accidents in Great Britain ²¹

Falling and slipping are the most common causes of non-fatal accidents. The development of these accident occurrences is still around 30% in 2017 and then diverges until 2019, only to converge again at 25% on average in 2020. The proportion of accidents caused by these two types of incidents has therefore not changed significantly and remains constant.

²⁰ Deutsche Gesetzliche Unfallversicherung e.V. 2020.

²¹ Health and Safety Executive Britain 2017-2021.

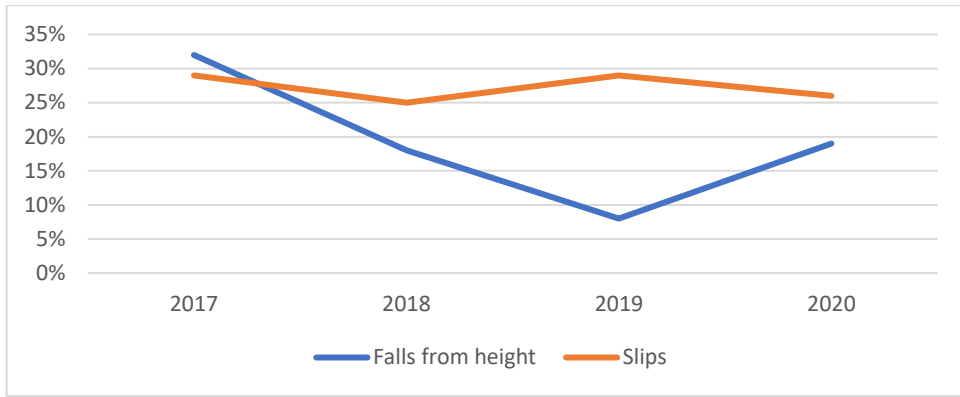

Figure 12: Percentages of the type for non-fatal occupational accidents in Great Britain ²²

In total, more than 6.3 million days have been lost due to occupational accidents (2020). This results in costs of £16.2 trillion that have to be borne by insurance companies. In addition to the pure accident statistics, the HSE also investigates the prohibition notices and improvement notices used within the construction industry. These are used as the first means of dealing with health and safety violations in order to improve the working environment or to immediately remedy dangerous situations.

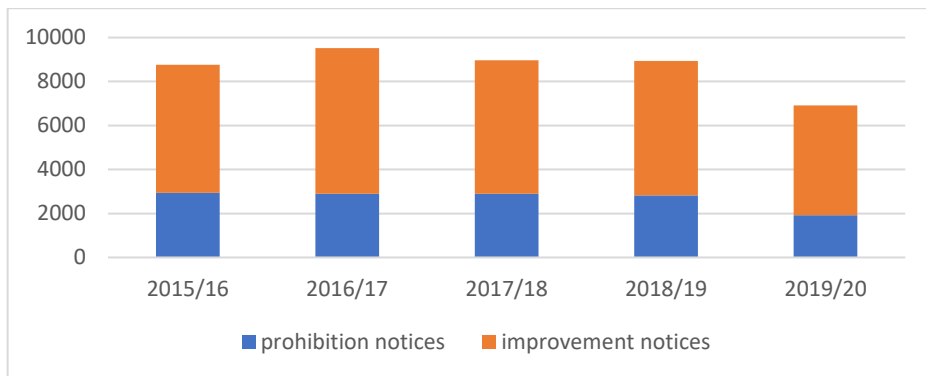

Figure 13: Development of prohibition and improvement notices²³

²² Health and Safety Executive Britain 2017-2021.

²³ Health and Safety Executive Britain 2017-2021.

3.1.3 Poland

In Poland, the Urząd Statystyczny w Gdańsku (Statistical Office in Gdańsk) keeps the current occupational accident figures for the country. Overall, Poland has an incidence rate of 4.54 accidents at work per 1000 inhabitants. The construction industry has an incidence of about 4.

Map 1. Persons injured in accidents at work per 1,000 employed persons^a in 2020 (excluding private farms in agriculture)

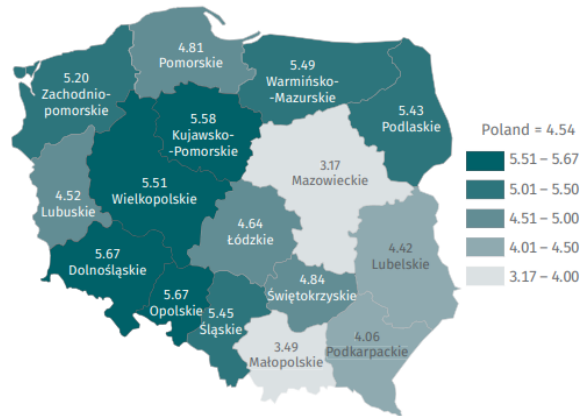

Figure 14: Distribution of occupational accident incidence rates by area in Poland²⁴

Most of the serious and fatal accidents at work occur among new entrants with up to one year of work experience (32.2% and 37.6%). The highest number of fatal accidents can be found in the construction industry (56.4%). In 2020, 2.8 million working days were lost due to occupational accidents. This represents a reduction of 20.4% compared to 2019. In most cases, lost days are between 4-13 days (27.2%) and 31-90 days (25.1%).

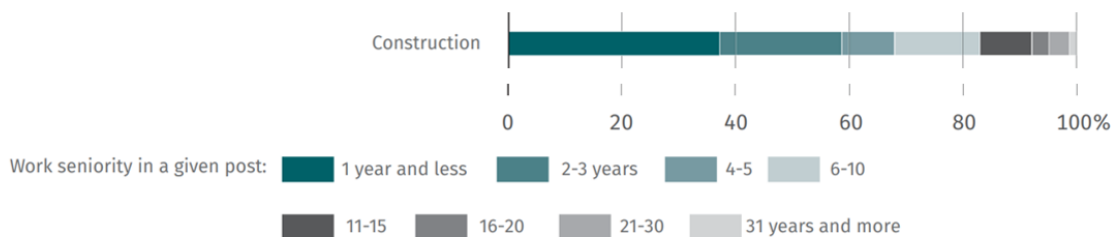

Figure 15: Age composition of employees in occupational accidents²⁵

Most accidents took place due to slipping, tripping or falling (28.8%). This also includes accidents on stairs and ladders, as well as falls from heights.

²⁴ Główny Urząd Statystyczny 2020.

²⁵ Główny Urząd Statystyczny 2020.

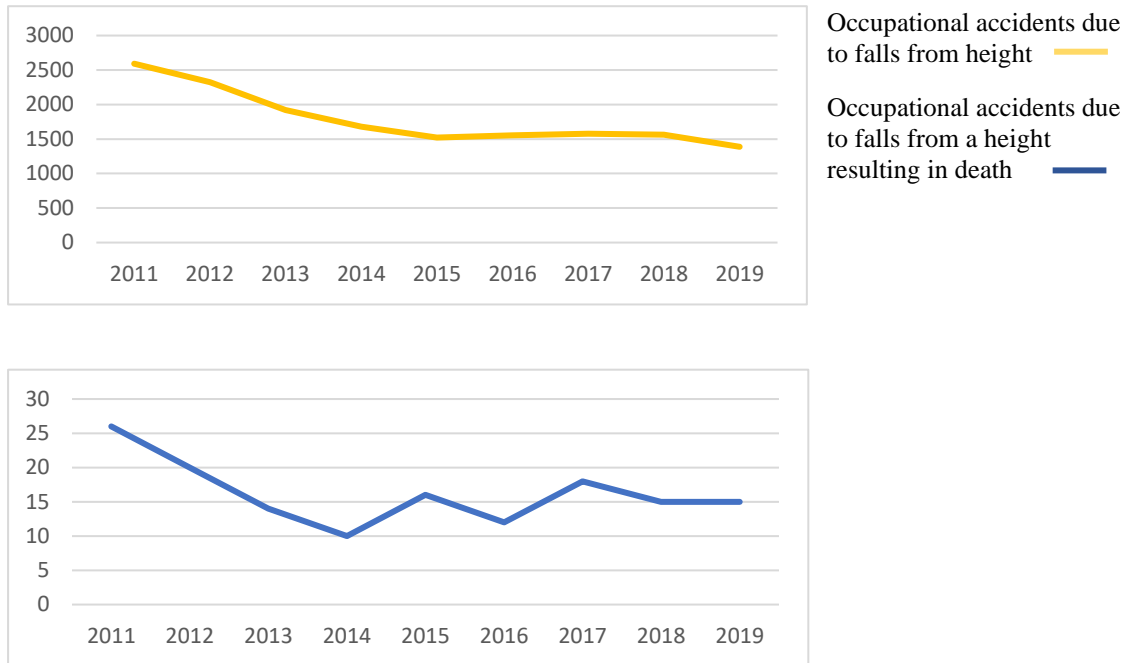

Figure 16: Development of occupational accidents due to falls and falls from heights in Poland 2011-2019²⁶

Overall, it can be seen that the number of accidents due to falls has been decreasing slightly since 2011. Fatal accidents decrease from 2011 to 2014 and then level off at around 15 per year.

3.1.4 Switzerland

In Switzerland, around 270,000 occupational accidents occur every year. The risk is highest in the construction industry, at 315 per 1,000 full-time employees (2019, civil engineering and building construction). More than every fourth accident is linked to slipping or sliding. Of these, 22% of accidents happen with stairs. Between 2015 and 2019, a total of 33.8% of accidents could be attributed to slipping or falling down. The number of accidents involving stairs has increased from 43,940 to 50,761 since 2010.²⁷

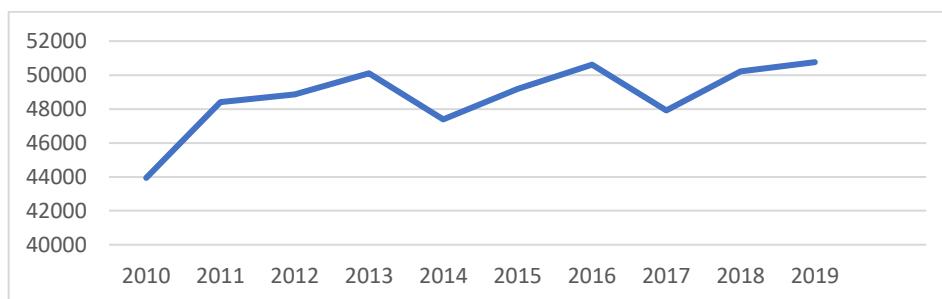

Figure 17: Development of occupational accidents involving stairs ²⁸

²⁶ Główny Urząd Statystyczny 2011-2019.

²⁷ Koordinationsgruppe für die Statistik der Unfallversicherung UVG 2010-2021.

²⁸ Koordinationsgruppe für die Statistik der Unfallversicherung UVG 2010-2021.

There are also clear age differences between the accident incidents. Slipping or sliding occurs more frequently with increasing age. Falling accidents also increase with age.

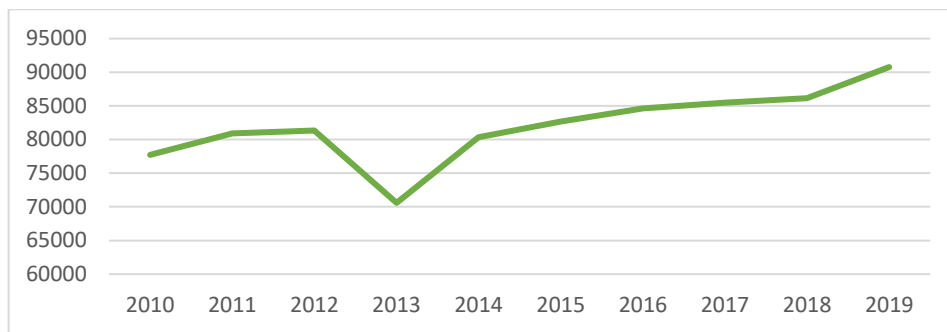

Figure 18: Development of occupational accidents due to slips and falls ²⁹

The most expensive accident categories are slips and accidents related to falls from height. On average for the years 2015-2019, the accident insurance institutions in Switzerland attributed 41% of the costs, i.e. the insurance benefits incurred, to occupational accidents caused by slipping and sliding. The same applies to falls. These caused a total of 22% of all costs in the assessment period.³⁰

²⁹ Koordinationsgruppe für die Statistik der Unfallversicherung UVG 2015-2019.

³⁰ Koordinationsgruppe für die Statistik der Unfallversicherung UVG 2015-2019.

3.2 Analysis and perspective

Overall, it is clear that accidents within the EU continue to be a significant issue. While the accident figures in the EU have fallen on average at the beginning of the statistics, they have stabilised in recent years and have remained largely constant at around 2.3 million cases. A closer look at the incidences of fatal accidents in particular shows that there are sometimes large differences between the individual Member States. In general, accidents at work are concentrated in the north-west of the EU borders, while accidents at work resulting in death are more frequent in the south-west and south-east. In 2.3 million cases, accidents at work resulted in lost work time of more than 4 days and thus in economically significant costs. In 40% of the cases (980,000) there are even lost working hours of more than 20 days. Whereas in Germany, for example, the total costs in 2019 amount to €11.125 billion³¹ it was estimated to be as high as £16.2 billion in the UK³². In 2019, there were a total of 3008 fatalities across the EU. A closer look at the individual countries has also shown that occupational accidents entail significant economic costs.

The European Union had a fatality incidence of 2.14 in 2019. The comparison of different member states also shows that very different safety standards prevail in practice. While an incidence of 0.49 was found in the Netherlands, France has an incidence of 4.6. The high variance speaks for an enormous potential for optimisation.

In perspective, a slight decrease in the number of accidents is due to the pandemic situation, which can already be seen in some individual values. However, with abolition of restrictions measures linked to the pandemic and with a rising economic performance, an increase in accidents is expected again. Accidents at work will always occur, so it is important to take targeted preventive measures and to adequately inform staff about the dangers and equip them with appropriate protective equipment. The safer workplaces, tools and equipment as well as machines are designed, the more accidents can be avoided. The comparison of incidences shows that some countries seem to place more emphasis on safety than others. It has also been shown that newcomers to the labour market and older workers in particular are often more affected by accidents at work. This can be explained by a lack of knowledge in the former case, or by the onset of motoric impairments and overestimation in the latter case. Repeated training and also special consideration of the demographic conditions should be considered here. Looking at accidents involving ladders and stairs, as well as slipping and falling in general, it was found to be one of the main causes of occupational accidents. In fact, it is also one of the main causes of all fatalities. Falling and slipping accidents cause above-average costs for insurance providers. Even falls from low heights can lead to serious injuries.³³ Therefore, appropriate measures must be taken to improve or at least maintain the safety of ladders and stairs.

³¹ DGUV forum 2020.

³² Health and Safety Executive Britain 2017-2021.

³³ BGBau 2022.

4 Theoretical research framework

4.1 Definition of research subjects

In the following, the two test objects are described and the underlying boundary conditions are presented. The general functional dimensions and applicable test specifications are explained in terms of the task.

4.1.1 Window-cleaning ladders

Ladders are auxiliary devices for reaching various vertical levels. In most cases, they consist of two bars that are connected by rungs. The rungs can be used for climbing up and down. Ladders can be made of different materials or a combination of . Wood, steel, aluminium and some plastics are used. Depending on the design principle, ladders can be leant against a wall or stand on their own in the form of a stepladder. Plug-in, sliding or telescopic ladders offer the possibility of individually changing the total length and thus also the working height.³⁴ To increase stability, the base of the ladder can be widened with additional crossbars. Single ladders are mainly used for window and facade cleaning.

Functional dimensions

For the definition of the design features and test methods applied, EN 131-1:2015+A1:2019, as well as EN 131-2:2010+A2:2017 and EN 131-3:2018 are decisive in the case of the ladder types examined, particularly, the ladder types 3.7 and 3.8.³⁵ According to the standard, the stabilising traverse is a "device attached to the lower end of the ladder for increasing the stand width. b_2 and to increase the stability ".³⁶The current minimum stand width for rung ladders, which also include extension ladders, can be found in Table 2 in combination with Figure 19:

Table 2: Functional dimensions for rung ladders³⁷

	b_1^a	b_2^a for $l_1 \leq 3000$	b_2^a for $l_1 \geq 3000$	l_3 and l_4^a	l_5	α
min.	280	340	$b_1 + 0,1l_1 + 2t$	$0,5l_5$	250	65°
max.	-	120	120	$l_5 + 15$	30	75°

a: This dimension also applies to individual ladder sections if they can be used separately, e.g. as single ladders
c: The measurement b_2 for single ladders may be limited to a maximum of 1200 mm at the discretion of the manufacturer.

³⁴ DIN EN 131-1.

³⁵ DIN EN 131-1, pp. 5–12.

³⁶ DIN EN 131-1, p. 11.

³⁷ DIN EN 131-1, p. 13.

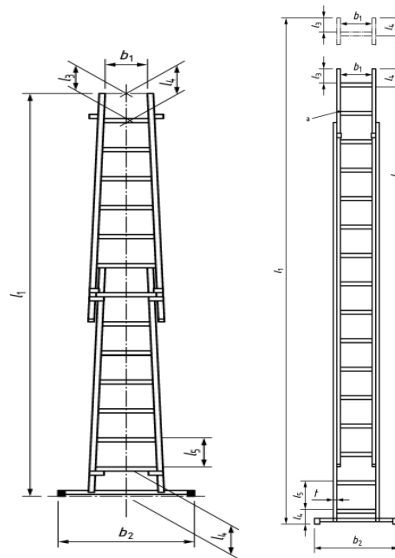

Figure 19: Types of extension ladders³⁸

For a ladder length of less than three metres, the minimum stand width b_2 of the truss is 34 cm. For ladders longer than three metres, the formula applies:

$$b_2 = b_1 + 0,1l_1 + 2t \quad [1^{39}]$$

The width of the ladder b_1 is the distance between the stiles. This is measured at the top of the ladder, at the shortest rung. The total length l_1 is the distance from the lower end of the ladder foot to the uppermost point of the ladder set up in maximum length. Depending on the ladder type, the ladder must be pushed apart or plugged together for this purpose. The stile thickness t is the outer dimension of the spar profile, measured perpendicular to the spar axis. The outer width b_2 (stabiliser/traverse width) of the ladder may be limited to 120 cm at the discretion of the manufacturer.

Test procedure

The previous general test procedures for single ladders according to EN131-2 can be found in abbreviated form in Table 2. The prescribed tests have so far been limited to the material behaviour and the load capacity of the ladders. The ladders are mainly tested under the aspect of a static maximum load. Dynamic loads are not taken into account in the test procedures, apart from the durability test. Safety-relevant effects, in particular tipping due to lateral or horizontal forces, are also not considered at present.

³⁸ DIN EN 131-1, p. 14.

³⁹ DIN EN 131-1, p. 13.

Table 3: Summary of test procedures for single ladders according to EN 131-2⁴⁰

Procedure	Criteria
Strength test	2700N vertical load, on middle rung, 50mm from stile 65° installation angle Derivation: 150 kg (rated load) × 1.7 (dynamic factor) × 9.81 (gravity) × 1.44 (safety factor) × 1.1 (material factor) × 0.6814 (factor for the simultaneous occurrence of 0.08 × 4 factors) = 2 700 N
Deflection spars	Preload 100 N, test load 750 N for 1 min on the middle of the beam
Lateral deflection	Preload 100 N, test load 250 N for 1 min on the span center of the spar
Buckling test	Test load 1100 N over 50 mm long test block at the end of the bar Only for ladders without stabilisers
Rung load	Test load 2600 N distributed over 100 mm in the middle of the bay of the weakest rung
Twisting of the rungs	Torque 50 Nm over 100 mm on the weakest rung for 10 seconds
Tensile testing of ladder feet and trusses	150N for 1min in the most unfavourable pulling direction
Slip resistance on the floor	1571 N in the middle of the 4th rung at an angle of 75°, place the ladder on float glass at 20°C
Torsion test leaning ladders	491 N preload, 638 N test load in the middle of a stile, place the support cylinder 200mm from the ends of the ladder

For the test methods listed in Table 3: Summary of test procedures for single ladders according to EN 131-2, limit deviations of ±1 mm for length measurements; ±5 mm for distances between supports, ±1° for angle measurements and ±1 % for static forces and torques apply. Strength tests are carried out on the fully extended/erected ladder. The single ladders were placed at an angle of 65° (75° for slip resistance testing) and leaning against a smooth vertical surface. At the end of the test, the load is removed and the ladder examined.

For the occupational use test load, the requirements of a maximum working load of 1471 N applied. The body weight and equipment of a professional are taken into account. These loads are extended by dynamic factors, safety coefficients as well as material factors according to the following formula.

$$150 \text{ kg (rated load)} * 1.7 \text{ (dynamic factor)} * 9.81 \text{ (gravity)} * 1.44 \text{ (safety factor)} * 1.1 \text{ (material factor)} * 0.6814 \text{ (factor for the simultaneous occurrence of } 0.08 * 4 \text{ factors)}$$

[2⁴¹]

With regard to the objective - the tilt stability test with reference to various boundary conditions such as stabiliser length and angle of attack - a test is developed based on the existing test procedures. Existing test criteria and test loads of EN131-2 are adopted, if reasonable. In particular, the expected load for commercial use, which is specified in the strength test, is used as the test variable for the maximum load on the conductors. However, as this load can also have a positive effect on the overall stability of the system due to the large vertical tensor, a reduction was investigated. The installation angle of the single ladder plays a role in the redirection of the vertical forces to the wall. Since a flatter angle provides a higher contact pressure and thus a stronger frictional force at the top of the ladder. This can also have a positive effect on the tipping

⁴⁰ DIN EN 131-2, pp. 15–55.

⁴¹ DIN EN 131-2, p. 19.

stability. The exact test procedure and the underlying boundary conditions can be found in chapter 5.1 (work package B). The selected test forces are also determined.

4.1.2 Loft ladders

Loft ladder systems are permanently fixed staircases that are installed in a ceiling opening. By lowering and mechanically folding out or extending the stairs, access is provided from a lower level to a higher level. Basically, a distinction can be made between concertina floor stairs, sliding/folding floor stairs and pull-out floor stairs.⁴²

Functional dimensions

The functional dimensions of loft ladder systems are specified in Table 2 of EN 14975:2006+A1:2010. The angle of inclination of the installed loft ladder must be between 60° and 80° for newel stairs and between 60° and 75° for stairs with treads. The installation of handrails must be made possible by the manufacturer from a stile depth of 76 mm. The treads must be profiled when metal and plastic are used to ensure adequate slip resistance. The distance between the middle of the treads and the trapdoor must also be at least 100 mm when in use. No specifications are made regarding the fasteners to be used and their durability; parts made of steel that are susceptible to corrosion must only be protected. Floor stairs must be secured against unintentional opening.

Table 4: Functional dimensions of loft ladder systems⁴³

	a	b	c	l_1	l_2	l_3	α
min.	100	240	20 (<i>rungs</i>) 80 (<i>treads</i>)	230	$0,5l_1$	$0,5l_1^a$	60°
max.	-	-	-	300	$l_1 + 15$	315	75° (<i>treads</i>) 80° (<i>rungs</i>)
a: There is no minimum dimension l_3 for extendable pull-out loft ladders							

⁴² DIN EN 14975, pp. 4–7.

⁴³ DIN EN 14975, p. 14.

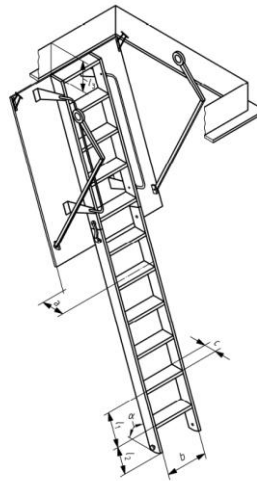

Figure 20: Illustration of a sliding/folding loft ladder⁴⁴

Testing criteria

An overview of the test methods according to EN 14975:2006+A1:201 can be found in table 4. In principle, a maximum working load of 1471 N is assumed. The tests were carried out under room temperatures between 15-20°C. The rungs/treading surfaces and the handrail were tested; connections or joints must not show any permanent deformations after loading. The ladder was also examined in a continuous load test. Here, the loft ladder was subjected to a cyclical load on the rungs in the fully extended state. Fatigue of the joints and connections due to repeated extension and retraction was not taken into account. The loosening of the connections over a longer period of time or under temperature fluctuations was also not considered.

Table 5: Testing method for loft ladder systems according to EN14975:2006+A1:2010⁴⁵

Procedure	Test criteria
Static load test	Preload of 1000N, at middle, top and most articulated tread surface. Test load of 2600N for 60 s
Endurance test	Cyclic 1500 N, 75 mm from the inside of the tie bar, 5000 times
Twist test of treads	Torque of 50 Nm, over 100 mm wide at tread centre, 10 times counterclockwise and clockwise for 10 s
Checking the handrail (only if provided by the manufacturer)	Vertical, parallel, lateral to the stair axis to each other 100 N, downwards 500 N, static load on the middle step 400 N
Testing the locking device of the loft ladder	Fixed, closed loft ladder is dropped 10 times from maximum height
Deflection test treads	Test load 2600 N over 100 mm distributed on centre of middle tread, 60 s

Limit deviations of ± 1 mm for length measurements, $\pm 1^\circ$ for angle measurements and ± 1 % for static forces and torques applied for the methods mentioned in Table 5. Strength tests were carried out on the fully extended/assembled ladder. The tests was carried out at a room temperature of 15-20°C. At the end of the test, the load was removed and the ladder examined.

⁴⁴ DIN EN 14975, p. 5.

⁴⁵ DIN EN 14975, pp. 8–13.

5 (Work package B) - Experimental Setup and results

On 27 July 2022, a kick-off meeting was held with representatives of the ETUC, the Arbeitsschutzzentrum Haan and the contractor. The various boundary conditions of the experiments carried out were discussed. The result of the coordination was that one ladder system is tested in the case of window-cleaning ladders. Another system is additionally simulated by calculation and validated by the data from the experiment. The aim is to determine the force/impact required to cause the ladder system to tip. By adjusting the stabiliser lengths, it is possible to investigate how much the overall stability in terms of lateral tipping suffers when the stabilising stabiliser is shortened.

With the help of a climatic chamber, it was investigated whether the screw connections loosen in the case of a wooden loft ladder system, which is mainly used in European households. Cyclic temperature testing were used to compare the loosening torques of the screw connections in order to make a statement about the durability and reliability of the connecting elements of simple loft ladder systems. The first results were presented and discussed in a further meeting.

5.1 Methodic procedure research subject A

The stability test was carried out mathematically using two different commercially available ladder systems that are typically used in window and facade cleaning. The test was then carried out on a ladder and was intended to validate the preceding calculations. Figure 21 and Figure 22 show ladders from the manufacturers Hymer and Munk. These ladders consist of light metal rectangular bars and a rubber strap at the upper end. The aim of the investigations was to validate the underlying calculation. The Excel tool developed could be fed with various parameters and individually adapted to the boundary conditions and dimensions of the different ladders. It could also be used to quickly calculate the parameters sought for other types of ladders. Due to the applicable specifications, the stand and working height of both ladders were limited to a maximum of 5 and 6.5 metres respectively.⁴⁶

⁴⁶ Ausschuss für Betriebssicherheit 2018.



Figure 21: Window-cleaning ladder ⁴⁷
Art.-Nr.: 96687035



Figure 22: Rung rope ladder ⁴⁸
Art.-Nr. 021214

Table 6: Properties of the testing subjects

Properties	
ladder rail ca. mm	73
length ca. m	7,1
stand height ca. m	5,00
working height ca. m	6,50
manufacturer	Hyer
width ca. mm	110/845
weight ca. kg	24

Properties	
ladder rail ca. mm	89/100
length ca. m	7,22
stand height ca. m	5
working height ca. m	6,5
Manufacturer	Munk
width ca. mm	420
weight ca. kg	21

⁴⁷ contorion.de 2022.

⁴⁸ steigtechnik.de 2022.

5.2 Methodic procedure research subject B

The ladder was gradually loaded horizontally in order to determine under which forces the stability fails and tipping occurs. In order to precisely determine the forces, the expected forces were briefly classified below.

Vertical and horizontal forces

In the case of the ladders under investigation, there is a general spatial force system. This means that the forces of the system are not directed to a point and are not located in a plane.⁴⁹ There are different forces acting on the ladder in its state of use. To simplify matters, a distinction could be made between 'vertical' and 'horizontal' forces. The self-weight and the applied test load could be counted among the vertical forces. The dead weight was applied to the centre of gravity of the ladder for theoretical consideration and calculation.⁵⁰ The vertical forces could be attributed to the tilting force. This was applied at the working height of the ladder and should virtually cover the effects of dynamic and wind loads. In other words, it was determined how high the resultant of the external load may become before the system becomes unstable. Dynamic loads can be, for example, the movement of a person on the ladder or external variable effects like wind forces.

Frictional force

The window-cleaning ladder makes contact with the wall surface when used and leaning against the wall. The resulting static frictional force depends on the surface properties of the two bodies that meet. In addition, the angle at which the ladder is set up has an influence on the amount of force transferred from the ladder to the surface against which it is leaning, which in turn has an effect on the maximum static frictional force.⁵¹

⁴⁹ Wetzell and Krings 1972, p. 1.

⁵⁰ Wetzell and Krings 1972, p. 65.

⁵¹ Hering et al. 2004, pp. 38–39.

Experimental set-up and execution

The test set-up consisted of investigating the influence of the stabilising stabilisers through different dimensioning. The ladders were set up in their fully extended state. The ladders were leant against a smooth surface at the most unfavourable angle of 75° . The test load was applied in accordance with the manufacturer's specifications for the maximum permissible load of 150 kg (approx. 1500N) to the maximum standing height of 5 m specified by the TRBS.⁵² The horizontal position of the test load should be placed at the most unfavourable point. This was the respective outermost area of the rung next to the tie bar, in the direction of the tilting force to be tested. The stabilising stabilisers were exchanged step by step from 1200>1100>1000>900>800 mm. One horizontal load per stabiliser was applied to the ladder stile at the specified working height (standing height + 1.5m) and the tensile force was increased until the ladder began to tip. If the test force could not be applied at this height, the results must have been converted accordingly. The development of the test force was documented. The test was still repeated in the following two variations.

- The effect of a reduced test load of 650N was checked. The test was repeated as described above. The results were recorded.
- Finally, it was tested how the tipping force develops in the event that the load is applied in the middle of the rung with a remaining crossbar length of 120 mm.

The ladder should not show any visible defects such as cracks or deformations during and after the test and should remain functional. Otherwise, the test would have been aborted and carried out under adapted boundary conditions.

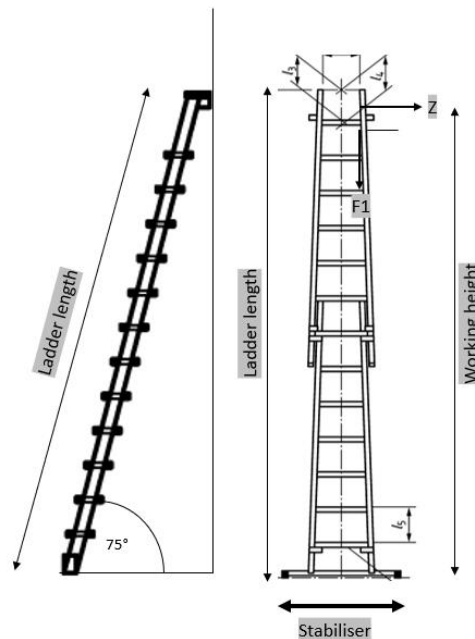

Figure 23: Schematic representation of the experimental set-up

⁵² Ausschuss für Betriebssicherheit 2018.

5.2.1 Results

Prior calculations

In addition to the test execution and evaluation, the expected results were calculated manually as an additional validation. For this purpose, an Excel worksheet was prepared that allows the individual boundary conditions to be varied. Through the validation by the test, the Excel worksheet could be used for the calculation of further ladder types. The calculation of the required tilting force was initially calculated without considering the influence of friction as follows. The location of the forces and variables could be seen in Figure 24.

$$F_{Kipp}[N] = [F_{Prüf}[N] * [(b_T[cm] * 0,5) - X_A[cm]] + (F_{EG}[kg] * 9,81 * 0,5 * b_T[cm])]/(l_{AH}[cm]) \quad (3)$$

$$\begin{aligned} (\text{tipping force [N]} = \text{testload [N]} * [(\text{crosshead [cm]} * 0,5) - \text{eccentricity [cm]}] + \\ (\text{deadweight [kg]} * 9,81 * 0,5 * \text{crosshead [cm]})) / (\text{working height [cm]}) \end{aligned} \quad (3)$$

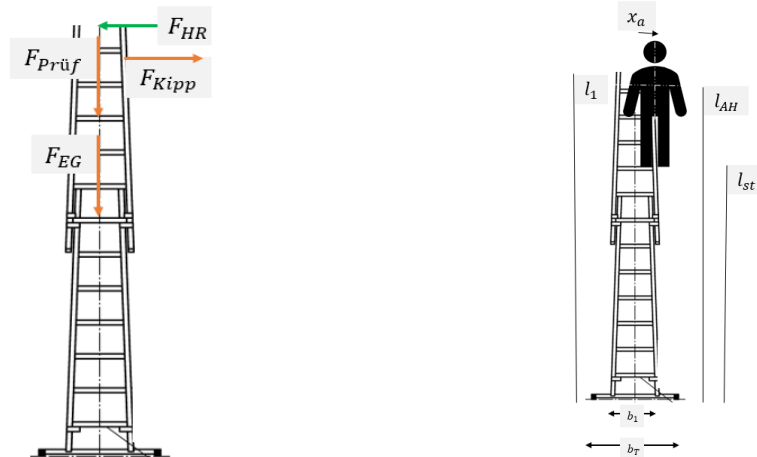

Figure 24: Forces and variables involving the calculations

The results show that the applied test force had a positive effect on stability and that its position on the ladder is the decisive criterion. Using the variables from Table 6, which result from the regulations and the manufacturer's specifications in Table 6, a tipping force of 112.47 N (11.47 kg) was obtained for a truss length of 120 cm. Figure 25 shows that the stability of the ladder decreases linearly with the reduction of the truss length. The calculation of the tilting force K, under the given boundary conditions, can therefore be done with the formula: $y_{[120-80]} = -1,3123x + 113,79$, with x equal to the stabiliser length. F_{Kipp} is 73.11 N (7.45 kg) for a truss length of 90 cm. This corresponds to a loss of stability of 35 % with a reduction of the truss width by 30 cm.

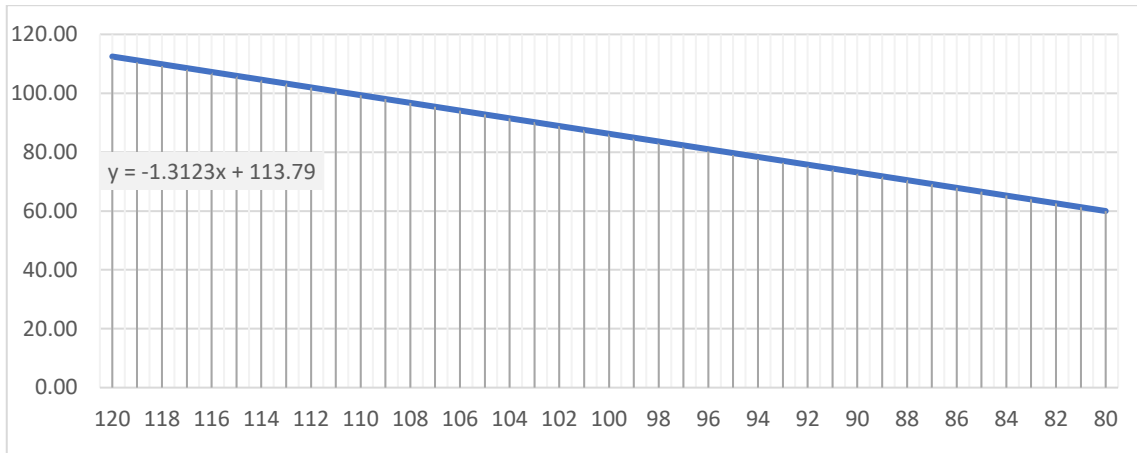

Figure 25: Graphical representation of the correlation of the tilting force [N] to the stabiliser length

Consideration of the frictional force

Since the ladder was placed at the upper end against a smooth surface (metal in the experimental setup) and was set up at an angle of between 65° and 75°, a force tensor was created which is dissipated into the wall. Depending on the material properties, this force causes an additional frictional force when the ladder moves horizontally, which acted against the tilting force. The calculation of the static frictional force resulted in (4), with the addition of the angle-dependent force acting perpendicularly on the wall:

$$F_{HR}[N] = \mu_{HR} [-] * F_R [N]$$

$$\text{with } F_R = (F_{Prüf} [N] * (l_{AH} * \frac{\sin(90-\alpha)}{\sin(90)})) + (F_{EG} [kg] * 9,81 * 0,5 * b_w)) / l_1$$

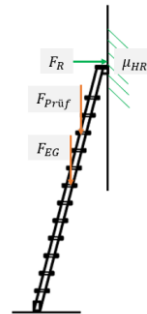

(4)

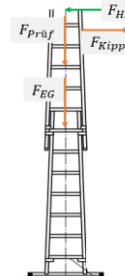

(5)

The static frictional force F_{HR} was added to formula (3). The overturning force including the static friction force of the ladder was thus given by:

$$F_{Kipp}[N] = [F_{Prüf} [N] * [(b_T [cm] * 0,5) - X_A [cm]] + (F_{EG} [kg] * 9,81 * 0,5 * b_T [cm])] + (\mu_{HR} [-] * F_R [N] * l_1) / (l_{AH} [cm])$$

(5)

With an as unfavourable as possible installation angle of 75 ° and a coefficient of friction $\mu_{HR} = 0,5$ (Rubber – Steel) with a stabiliser length of 120 cm and the test load at the axis height of the beam, an F_{Kipp} of 321,4 N (32,76 kg) was calculated. If the stabiliser width is reduced to 90 cm, F_{Kipp} is reduced to 282,03 N (28,75 kg). This corresponds to a loss of stability of 12.25 %. Compared to the calculation without friction force, there is a significant difference. The graphical comparison, with reference to the same parameters as in Table 6, can be seen in Figure 26.

Table 7: New parameters including consideration of static friction force

Parameters				
Ladder length	722	cm	Stabiliser lengths	120.00
Working height	650	cm	Wall height	697.40
Standing height	500	cm	Wall distance	186.87
Test load	1500	N	Friction coefficient	0.50
Position test load	19,5	cm	(from the centre)	
Static friction coefficient	0,5	-	Resulting force on the wall	376.17
Set-up angle	75	°	Static friction force	56.43
Own weight	21	kg		
Ladder width	42	cm		

The comparison of the different tipping forces and the associated loss of stability shows that the frictional forces have a significant share in the stability of the ladder.

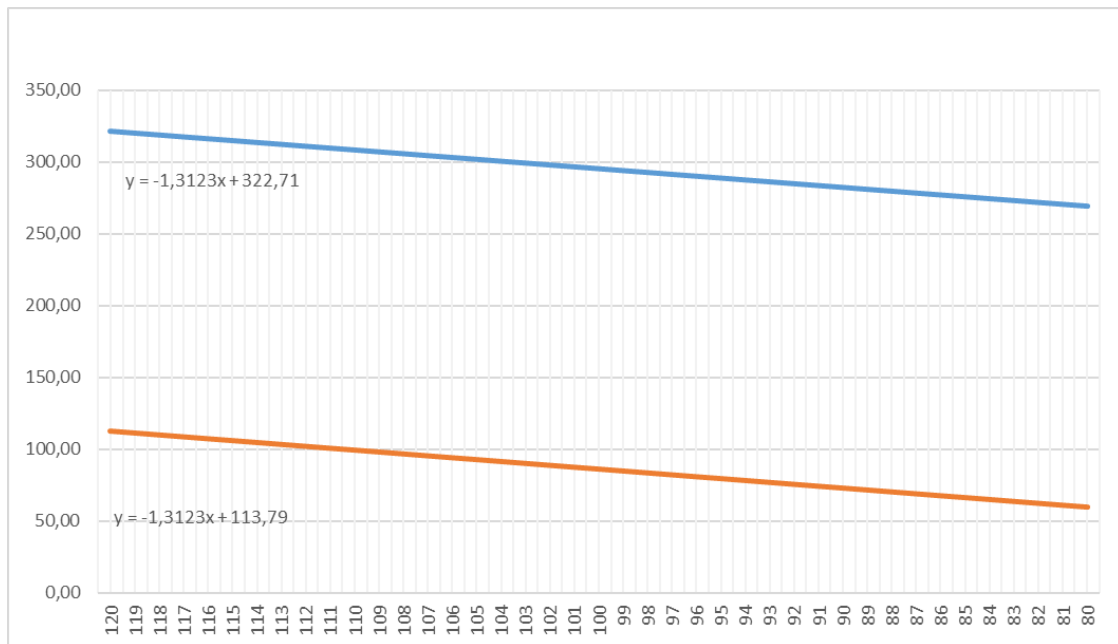

Figure 26: Comparison of the calculated overturning forces with and without consideration of static friction forces, orange: without static friction, blue: with static friction

The tilting force under the frictional influence of the ladders on the wall can also be calculated as a linear formula with $y_{[120-80]} = -1,3123x + 322,71$. Both graphs have the same slope. Overall, a high relevance of static friction for the overall stability of the system can be noted.

In addition to the influence of static friction on stability, the influence of the test force or, ultimately, the weight of the user is examined in the following pages. For this purpose, the parameters of Table 7 are adjusted as follows. The test weight should reflect the impact of both heavy users

and light users. Therefore, the test load was reduced from 1500 N to 650 N (66 kg). The angle of attack, working height and standing height remained unchanged.

Table 8: Adjusted parameters

Parameter				
Ladder length	722	Cm	stabiliser lengths	120.00
Working height	650	Cm	Wall height	697.40
Standing height	500	Cm	Wall distance	186.87
Test load	650	N	Friction coefficient	0.50
Position test load	19,5	Cm	(from the centre)	
Static friction coefficient	0.5	-	Resulting force on the wall	178.12
Set-up angle	75	°	Static friction force	26.72
Own weight	21	Kg		
Ladder width	42	Cm		

Figure 27: shows the comparison of the new parameters with the previous calculation. Although the loss of stability of the system is approximately the same at 12.47%, the force F_{Kipp} with a crossbar length of 120 cm lies at 158.44 N (16.15 kg). With a reduction to 90 cm, this is only 138.68 N (14.07 kg). The significance of the user's own weight can thus also be noted as decisive for a stability consideration.

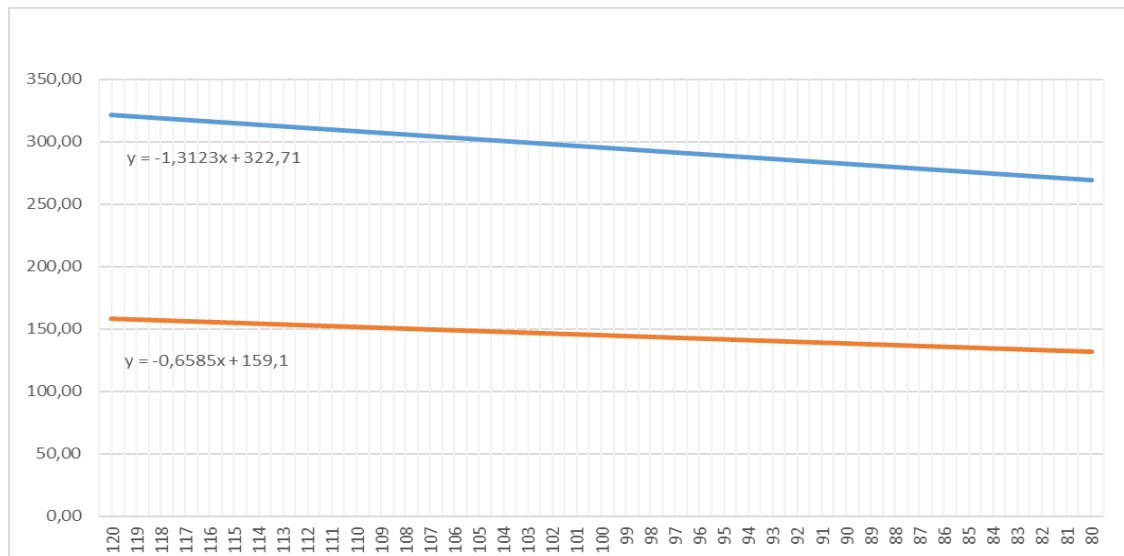

Figure 27: Comparison of the changed parameters, orange: 1500N, blue: 650N

In addition to the test load caused by use, the frictional force could be considered one of the greatest influencing factors on the stability of the ladder. Since the frictional force depends essentially on the angle of installation and the surface roughness of the contact surfaces, a complex scenario of various boundary conditions arises with every use. A direct comparison of

the calculated scenarios shows that in the worst case a person with a low body weight and a steep angle of attack uses the ladder. If, in addition, the contact surfaces of the ladder are wet, e.g. due to rain or wiping water, the frictional force can quickly decrease, resulting in a severe loss of stability.

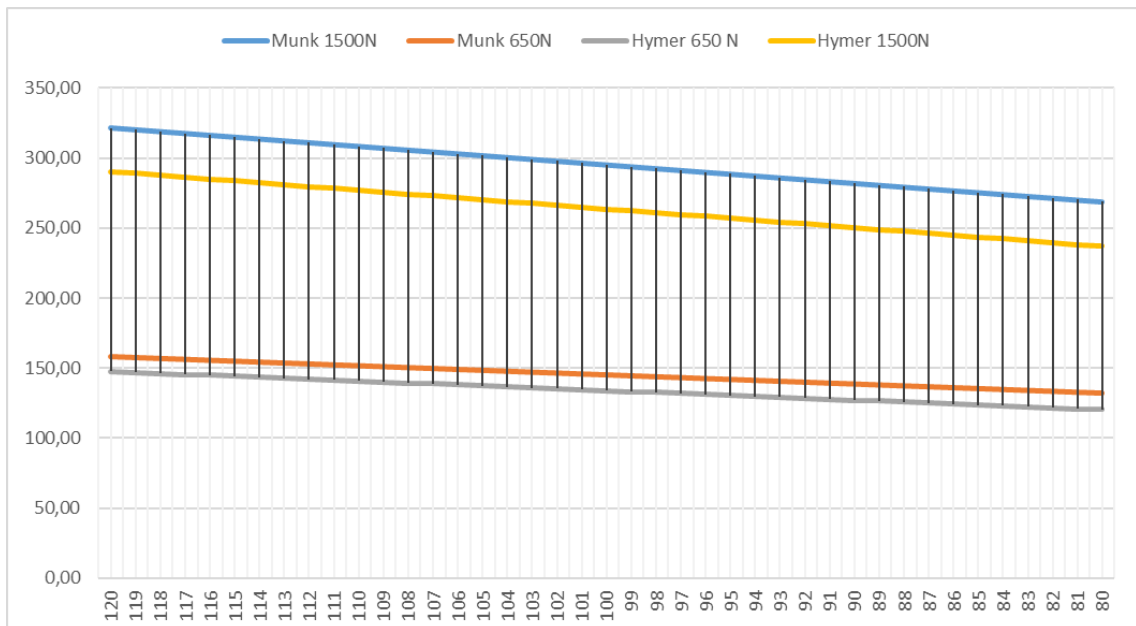

Figure 28: Overall comparison of the test objects [N]

Validation through testing

In addition to the pure calculation of the occurring forces for the prior estimation of the results, the test was also carried out in the test laboratory of the Arbeitsschutzzentrum Haan. The ladder used from the manufacturer Munk was also used as the basis for the calculations. Thus, the test can ideally be used as a validation of the results or, in the case of deviations, point to further acting forces that were not considered, or deviated.

5.2.2 Test execution subject A

In the test hall of the Arbeitsschutzzentrum Haan, the Munk ladder was leaned against a stabiliser at an angle of 75° . The ladder was only extended to a standing height of 5 m and a corresponding working height of 6.5 m. The ladder was then used for the test. A scaffold was placed next to the ladder, which allows the various test weights to be changed on the ladder during the test without stepping on it. At the level of the second rung from the top, the test cell was placed to measure the overturning force. The test cell was loaded horizontally from the side via a pulley. The test weight was attached to the outside left of the rung with a loop. The test weights were brought into position with a gantry crane and slowly hooked in so that the load does not start abruptly. The stabiliser was marked every 5 cm, for easy adjustment. After the test, the weight was lifted from the crane again, the stabiliser was loosened and shifted by 5 cm, as in Figure 31, so it became shorter on one side. The tests were repeated per test weight until all stabiliser lengths had been tested. Then the test weight was changed. At the end of the tests, the tipping force was determined for both test weights in case they were placed in the middle of the ladder rung.



Figure 29: Experimental set-up

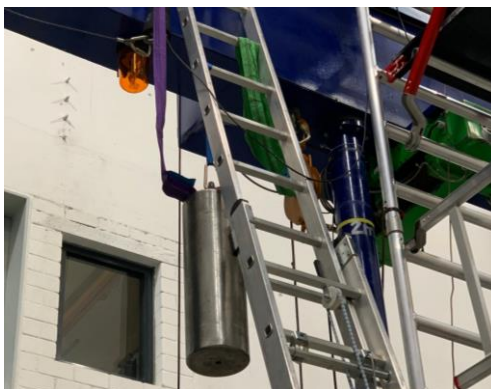

Figure 30: Test weight on the ladder



Figure 31: Marked stabiliser

Results

The forces that occurred during the test can be seen in Table 7. At the beginning of the test, in the case of the test weight of 1500 N, a tipping force of 145 N (14.78 kg) occurred with a stabiliser length of 120 cm. When shortened to 90 cm, a tipping force of 132N (13.46 kg) occurred. This corresponds to a loss of stability of approx. 9%. In the case of a test weight of 650 N the loss was considerably higher. With a stabiliser length of 120 cm, a tipping force of 101N (10.3 kg) occurred, which was reduced to 76 N (7.75 kg) with a 90 cm stabiliser. The loss of stability is approx. 25%.

Table 9: Results of the test under real boundary conditions

Load	Stabiliser [cm]	Max. Load [N]
1500N	120	145
1500N	110	137
1500N	100	134
1500N	90	132
1500N	80	126

Load	Stabiliser [cm]	Max. Load [N]
650N	120	101
650N	110	90
650N	100	82
650N	90	76
650N	80	76

If one compares both results graphically, an almost linear course of the tipping force in relation to the stabiliser length can be seen. The test force or the weight of the user also has a considerable influence on the basic level of the tipping force. The different inclines indicate that the frictional force also has a variable influence on the tipping force depending on the test weight.

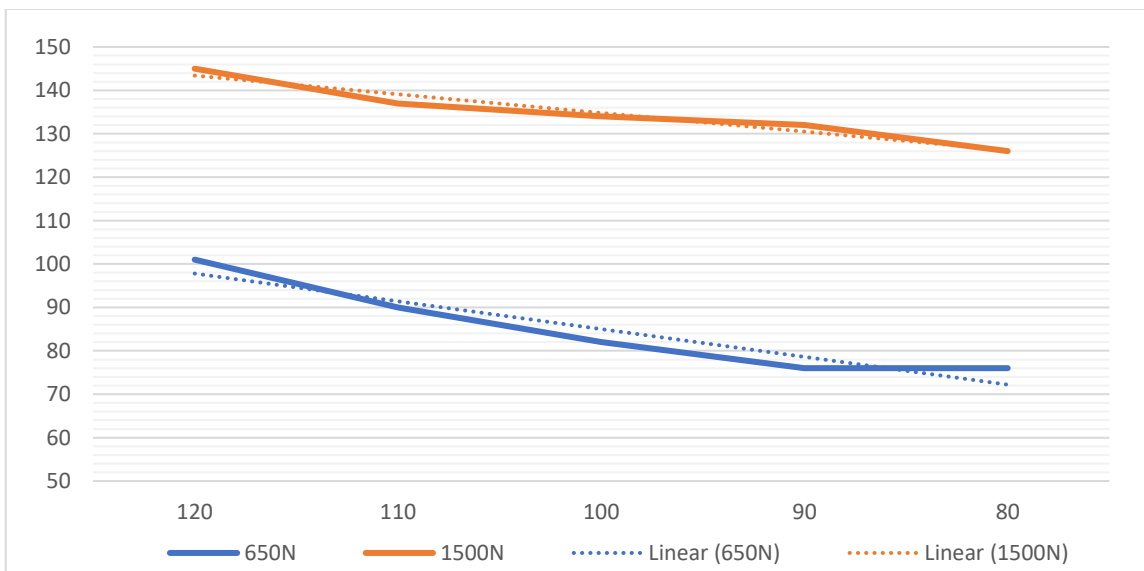

Figure 32: Graphical representation of the tilting force as a function of the stabiliser length

Comparison and analysis

The following graph shows the direct comparison of the calculated tipping forces and the forces determined in the test set-up. It can be seen that the deviations of the correlating calculations with the real tests are particularly noticeable with the higher test weight. This is mainly due to the real boundary conditions and test inaccuracies, as well as incorrect assumptions. The real tests showed that the ladder started to slip at the upper contact surface, which indicates a much lower static friction than assumed originally.

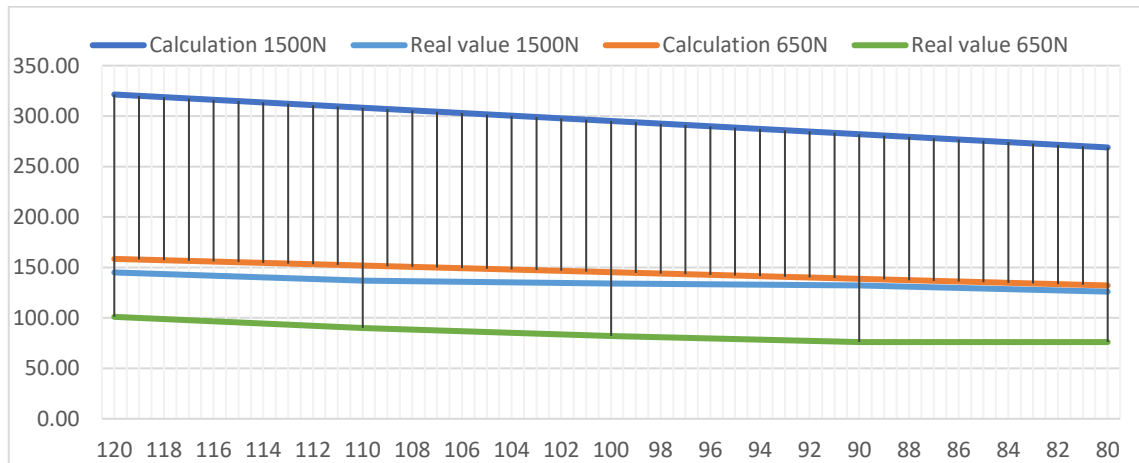

Figure 33: Comparison of calculations and carried out testing [N]

If the static friction force is adjusted to 0.12 [-], the graphs match more and overlap partly. The slope is also approximate, although in the case of the larger test load, clear differences can still be seen. The testing weight seems to have a more stabilising influence than calculated.

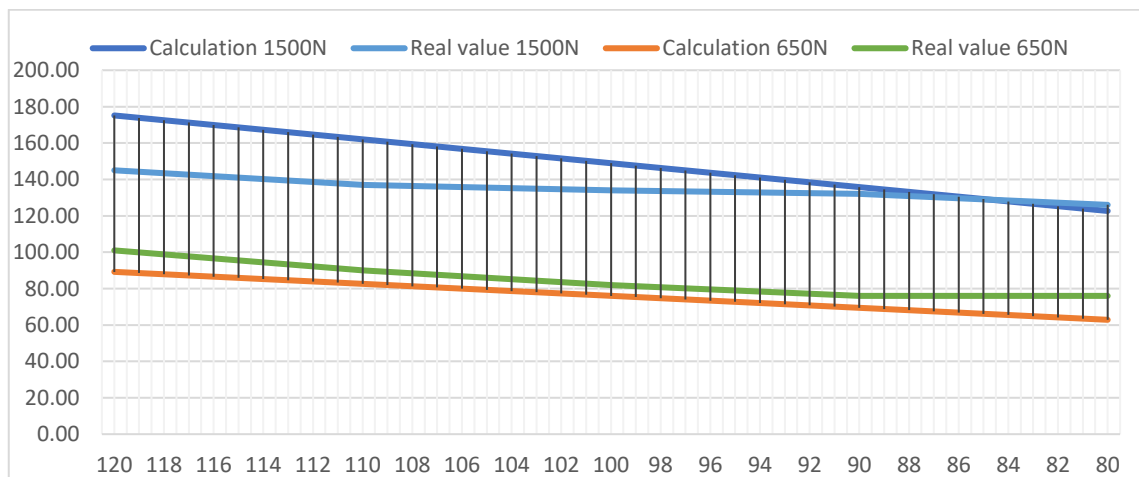

Figure 34: Comparison of adjusted calculations and carried out testing [N]

5.3 Methodic procedure research subject B

Scientific foundation

Screw failure

For the test, the bolted connections are probably of particular relevance. Vibration stress in particular often leads to loosening of bolted connections due to creep/settling or automatic loosening. The failure of the connection can be caused by three reasons: Dimensioning errors, assembly errors and improper use of thread lockers (Figure 35).⁵³

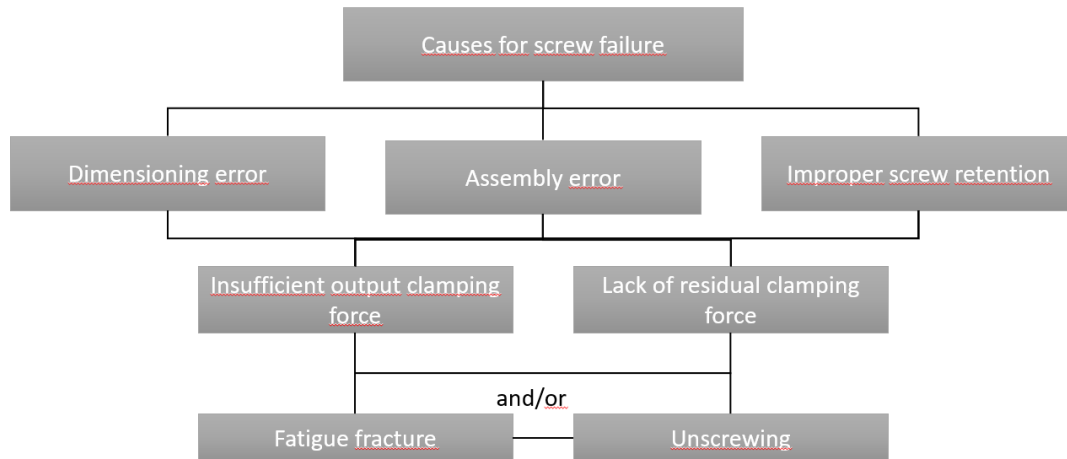

Figure 35: Causes of unfastening and failure of bolted joints ⁵⁴

Immediately after assembly, the pre-tensioning force could drop, which leads to the loosening of the connections. One of the most common cases is the setting of the bolted joint. Setting is the "levelling of surface roughness"⁵⁵. The occurrence of a settlement depends on the tightening method, strength of the connected parts, roughness of the contacting surfaces, profile shape, as well as the type of stress (pressure, thrust, temperature, tension).⁵⁶

Wood moisture

Wood is a hygroscopic material and absorbs moisture from the environment and can also release it again. This is due to the high capillary porosity, which makes it possible to absorb up to 150% of the moisture in relation to the kiln-dried state (absolute dryness). Since the wood always strives for a state of equilibrium with the ambient humidity, there is always a residual moisture content, depending on the humidity. If there is a moisture gradient in one direction, wood absorbs or releases more moisture accordingly.⁵⁷ The increase or decrease in moisture content is accompanied by shrinkage and swelling of the material. When the fibres of the cell wall are completely saturated with water (on average 30% for each type of wood), the wood is at the fibre saturation point. More water can still be absorbed between the cell cavities, but the further

⁵³ Wiegand et al. 2007, p. 379.

⁵⁴ Wiegand et al. 2007, p. 380.

⁵⁵ Wiegand et al. 2007, p. 381.

⁵⁶ Wiegand et al. 2007, p. 381.

⁵⁷ Koenders et al. 2020, p. 225.

increase or decrease in moisture has no further effect on shrinkage and swelling. In general, swelling occurs until the fibre saturation point is reached. Shrinkage only starts again when the value falls below the saturation point.⁵⁸ Since wood is an anisotropic material, the volume change in axial, tangential and radial direction to the wood fibre occurs in different magnitudes (Figure 36).

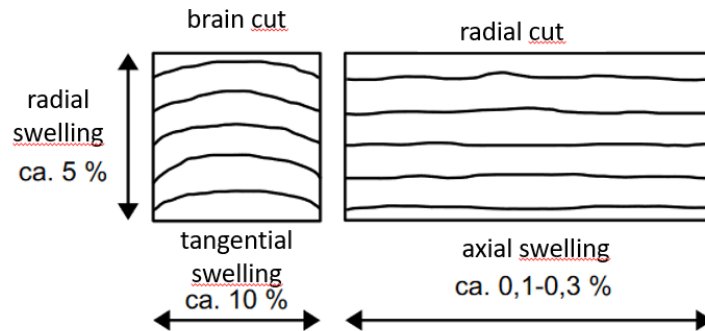

Figure 36: Maximum change in length due to contraction and shrinkage⁵⁹

The change in length of the wood in each direction is calculated with the differential shrinkage α_i [%] and the difference in moisture content Δu [%]:

$$\Delta L = \frac{L * \alpha_i * \Delta u}{100\%} \quad 60$$

In the present case, the screw connections were inserted tangentially to the wood fibre. With a thickness of the material of 3 cm (spruce), a maximum length change of 2.7 mm can theoretically occur, if the dried state of the wood is assumed. Above all, the shrinkage of the wood would have a negative influence on the pretension of the screw. In reality, an initial moisture content between 15 and 20 % is expected. This would result in a maximum length change of 1.6 mm.

Temperature exposure

Under temperature stress, materials expand with a few exceptions. The expansion depends on the temperature, as well as the structure and type of the material.⁶¹ In the present case, the temperature expansion of wood and metals, especially steel, were considered. The linear expansion of a given substance can be taken from the formula:

$$\Delta l = \alpha * l_0 * \Delta \vartheta \quad 62$$

⁵⁸ Koenders et al. 2020, pp. 225–226.

⁵⁹ Koenders et al. 2020, p. 228.

⁶⁰ Koenders et al. 2020, p. 228.

⁶¹ Dobrinski et al. 2010, p. 166.

⁶² Dobrinski et al. 2010, pp. 66–68.

With α [-] the coefficient of thermal expansion l_0 [cm] the length of the material and $\Delta\vartheta$ [K] the temperature difference in Kelvin.

While steel has a relatively high coefficient of linear expansion of $16 * 10^{-6}$ [$^{\circ}\text{K}$], wood has a coefficient of $5 * 10^{-6}$ [$^{\circ}\text{K}$]. At an initial temperature of 20°C and a temperature difference of 30°C or 30 $^{\circ}\text{K}$ in both directions (-10°C and 50°C), this corresponds to a change in length of 0.012 mm for the steel and 0.00375 mm in the case of the wood.

Thermal expansions are elastic, i.e. reversible. Only at very high temperatures do deformations occur that are no longer reversible. Failure of the materials themselves due to temperature stress and the given boundary conditions can be ruled out.⁶³

⁶³ Wiegand et al. 2007, pp. 280–282.

Experimental set-up and execution

For the test, the loft ladder system was first pre-assembled. The screw connections that were mounted by the user were tightened with a torque meter to 2.5 Nm. Screws that have already been mounted by the manufacturer were randomly tested for their release torque. This was documented. Since, according to the manufacturer's instructions, a screwdriver is to be used during assembly, the value of 2.5 Nm was specified for tightening the screws. All other screws pre-assembled by the manufacturer were not tightened and were left in their original condition. After all screws had been treated according to the specifications, they were permanently marked in their position. This could be done with a suitable pen or by scribing the screws (see Figure 37). The loft ladder was placed in the climate chamber in one piece in its folded position. The temperature of the climatic chamber was changed cyclically from -10°C to + 50°C. At the beginning of the test procedure, the humidity was set to 80% and the temperature to 50°C. The test was carried out in 60 cycles. A total of 60 test cycles were carried out. After the last cycle, the loft ladder was removed from the climate chamber as soon as it acclimatised. Subsequently, the function of the joints was checked by unfolding and folding the ladder. Any changes were documented. After all bolted joints had been visually inspected and any changes had been documented, the release torques were determined and documented for each bolt.

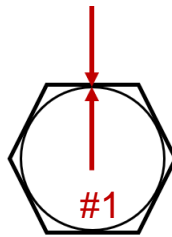

Figure 37: Marking the screws for observation purposes

5.3.1 Test execution subject B

After delivery of the loft ladder system, the ladder was first pre-assembled according to the operating instructions. All screw connections that have to be mounted by the user were initially only screwed in halfway to make it easier to distinguish them. A total of 44 screws were pre-assembled by the manufacturer. 14 screws had to be tightened by the user during assembly, 6 of which were pre-assembled and were used to fix the cover. 8 screws had to be newly mounted to connect the lower ladder section (Figure 40).

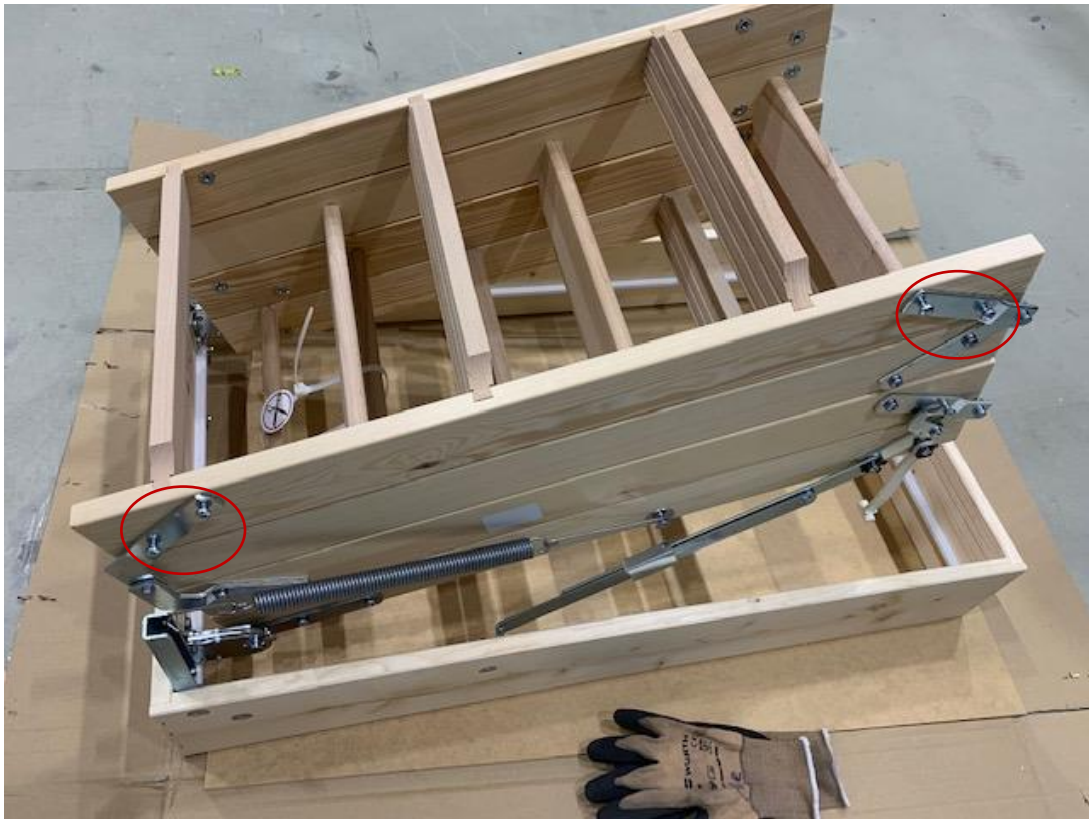

Figure 38: Loft ladder system preassembled, screws to be installed are marked

The screws installed were M6 x 25 screws with a cross recess half round head. The screws were inserted through the wood and screwed into an existing drive-in nut on the back. The absence of washers, lock washers and snap rings was marked during assembly. The screws used also had no locking teeth to secure their position.



Figure 39: M6 x 25 Phillips screw, half round head⁶⁴

⁶⁴ Digi-Key Electronics 2022.

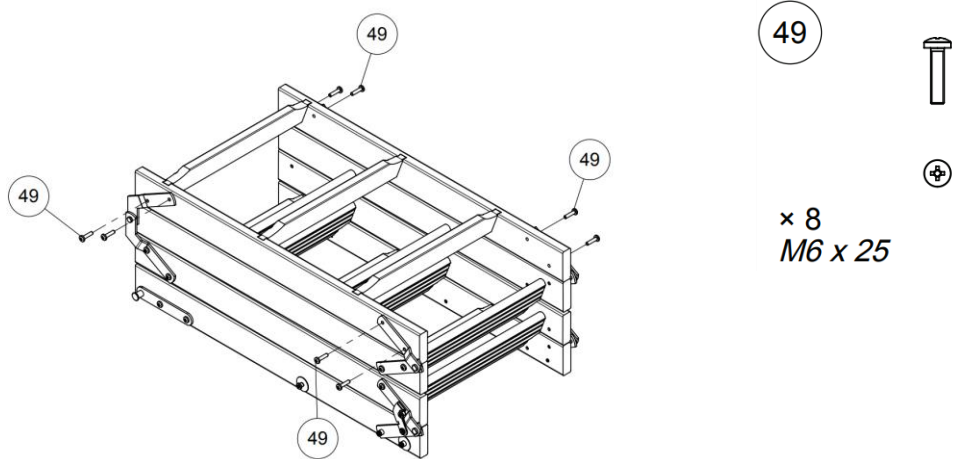

Figure 40: Section of the assembly instructions, position 49

All screws that were not pre-assembled (position 49) were tightened to a torque of 2.5 Nm using a torque meter. As described in the test set-up, the manufacturer-mounted screws were randomly tested for their release torque and then tightened to 2.5 Nm. The release torque of the screws that were tightened with 2.5 Nm was also checked. The values recorded can be found in Table 10.

Table 10: Release torques of the self-assembled and manufacturer-assembled screws

Position	Release torque [Nm]	Location
Release torque screw 7 (manufacturer side)	0.6	
Release torque screw 8 (manufacturer side)	0.8	
Release torque screw 32 (manufacturer side)	0.7	
Release torque screw 33 (manufacturer side)	0.8	
Release torque screw 34 (manufacturer side)	0.5	
Release torque screw 1 (assembly with 2.5 Nm)	2.1	
Release torque screw 2 (assembly with 2.5 Nm)	1.9	

After completion of the preparations, the entire loft ladder was placed in the climate chamber (Figure 44) in the collapsed position.



Figure 41: Climate chamber of the Haan Occupational Safety and Health Centre

The climate chamber used required approx. 55 minutes for one cycle (-10 to +50°C). The final temperatures are maintained for 5 minutes. The first cycle started at a temperature of 50°C with 80 % humidity.

5.3.2 Results

After the test cycles were completed, the ladder was removed from the climate chamber and moved to a room for acclimatisation. The bolted connections were visually inspected. No changes could be detected. No noticeable changes could be found in the wood either. The function of the ladder was not restricted. The bolts were loosened in sequence using the torque meter. The obtained release torques can be found in table 11.

Table 11: Release torques for the screwed connections after the test cycle

<i>Position</i>	<i>Release torque</i>	<i>Position</i>	<i>Release torque</i>
1	1.1	27	1.2
2	1	28	1
3	1.7	29	2.1
4	1.6	30	2.9
5	1.3	31	0.9
6	2.1	32	2
7	2.5	33	2
8	1.6	34	1.4
9	1.2	35	1.4
10	1.4	36	1.1
11	1.9	37	1.3
12	2	38	1
13	1.5	39	0.9

14	1.7	40	2.1
15	1.4	41	2
16	1.4	42	0.7
17	1.6	43	0.6
18	2.1	44	0.7
19	1.8	45	1.1
20	1.2	46	1.1
21	1.9	47	0.9
22	1.2	48	1.8
23	1.4	49	1.4
24	1.9	50	1.1
25	1.1	51	1.3
26	1	52	1.2

Compared to the reference values before the test cycles, the expected release torques increased in the majority of cases. 5 of the bolted joints had a release torque below 1 Nm. On average, the bolts had a release torque of 1.46 Nm. At peak, a value of 2.9 was achieved.



Figure 42: Overview of the tested screwed joints

Already during the test set-up, the difference in the release torques compared to the screws mounted by the manufacturer and the self-tightened screws was noticeable.

It can be assumed that the screw connections were made under different humidity conditions or that the conductors had a different humidity content when the screws were first tightened. This assumption is also supported by the test results. The air humidity and thus also the moisture content in the wood has a significant influence on the release torque of the screws. The wood apparently swells and shrinks so much in the tangential direction that it has a significant effect on the screw connections. These are connected at the back with impact nuts that are anchored in the wood. The swelling and shrinkage of the wood changes the hole depth and thus the distance between the bolt head and the nut. If the wood expands, the distance is extended and the pressure of the screw head on the wood increases. If the wood shrinks due to low humidity, the contact pressure of the screw head on the wood also decreases. As a result, the release torque also decreases. No failure or loosening of the screws induced by the strong temperature fluctuations could be detected over a test cycle of 60 periods.

As the bolted joints were only tested in an acclimatised state at around 20°C room temperature, it is likely that the shank length of the bolts also changed under the given temperature load, but that this is only observed in short-term elastic deformations. This is in contrast to the higher moisture capacities of the air under higher temperatures, which in turn would result in swelling of the wood and thus negation of the shaft extension.

Contrary to expectations, the tests did not result in the most unfavourable conditions and further loosened the bolted joints. By starting the test cycle with 80% humidity, additional moisture got into the wood. During the stay in the climate chamber, a humidity of 19.4% at -10°C and 51% at 50°C was achieved. This indicates the absorption of the remaining moisture into the wood. Because of the swelling of the wood associated with the absorption of moisture, the depth of the shaft between the bolt head and the nut increased slightly. This has led to higher release torques. It can be concluded that both temperature and especially humidity are significant boundary conditions for the safety of bolted joints. Conversely, it can be concluded that the release torque of the bolts would have been further reduced under high temperatures and low humidity. If other influences and regular movement are added, a complete unscrewing of the bolts cannot be ruled out. The fact that the screws only had a release torque of 0.5 Nm during the first inspection must be regarded as a cause for concern. In addition, the screws mounted by the manufacturer were pre-assembled, especially on the joints and other load-bearing parts. An increased safety risk must be assumed if the bolts were not retightened by hand. In order to observe the exact behaviour of the screws and the wood under moisture and temperature stress separately, DKMS test stiffeners could be used in further investigations.

6 (Work package C) – recommendation for action

6.1 Analysis of the results subject A

The tests have confirmed the assumption of an approximately linear decrease of the tipping stability with a decreasing truss length. In particular, the test weight, the angle of attack, the positioning on the ladder and the static friction have an influence on the tipping force. The tests showed that the real tipping force is even lower and the loss of stability even higher than initially calculated. By comparing different static friction coefficients in the calculations with the real results, it can be concluded that the static friction acts to a significantly lesser extent than assumed mathematically under ideal conditions. It must also be taken into account that during the use of the ladder, surfaces cause even significantly less friction. Or that because of the given boundary conditions (outdoor area, wetness, wiping water, etc.) even more unfavourable properties occur that result in a further reduction in stability. Overall, a reduction in stability as a result of a decreasing truss length can be confirmed by both the calculations and the tests. The amount of the percentage loss of stability per centimetre of truss shortening depends on the local boundary conditions, and in the extent is largely dependent on the user weight. In addition to the loss of stability when the truss length is reduced, it is also important to point out the generally low tipping forces. Since only static forces were taken into account in the tests and dynamic forces such as wind forces or movements and shifts of the centre of gravity on the ladder were not tested, their negative influence on safety must also be taken into account in further evaluations. On average, a reduction of the stabiliser from 120 cm to 80 cm resulted in a drop in stability of 14.7%. This corresponds to a loss of stability per cm of 0.36%.

6.1.1 Recommendation

Overall, both the calculations and the tests showed a loss of stability of the ladders due to the shortening of the crossbars. The loss of stability was confirmed to be approximately linear, so that there is a percentage loss of stability per cm of shortening of the crossbar. The weight of the ladder, the angle of installation, the weight of the user, the working height and the surface quality of the contact surfaces can also be identified as decisive boundary conditions. The results were calculated under ideal conditions and turned out to be significantly worse in reality. It was concluded that the frictional force is much less effective in reality than previously assumed. During the test and the calculations, no additional forces such as wind, dynamic loads or different surfaces were considered. Because of these factors, a further significant reduction in stability is expected in reality. In the future, dynamic forces could be considered more closely in corresponding safety tests and, if necessary, taken into account as a partial safety value in corresponding test procedures. Likewise, in addition to the pure material tests, test procedures which mimic a real application should be used. The human factor must be taken into account as a further boundary condition. The user being of a low weight leads to a significantly lower stability than would otherwise be the case.

Research into accident data has shown that accidents involving ladders and stairs are costly and accidents are widespread throughout the EU. Accidents with fatal consequences are possible even from low heights.

Based on the findings presented, it is recommended that:

The consideration of the overturning moment, or the corresponding tensor, should be considered in the EN standard up to a certain level and included in addition to the material inspections and tests carried out. A standardised test based on the experimental set-up of this report would also be feasible. Efforts should also be made to reduce the safety risk of the human factor. The accident data showed that especially young professionals and older people have an increased risk of being involved in accidents. It is precisely these groups that need to be made more aware. Age-appropriate work, which is becoming increasingly important due to demographic change and the shortage of skilled workers, should also be considered. Training courses could be held more often for both newcomers to the profession and users of advanced age, or other stand- and working- heights could be introduced for this group. It would also be possible to require an accompanying person, similarly to the driving licence with accompanying driving, until a certain level of professional experience has been reached. Especially within the risk assessment of the work to be carried out, the factor of age and professional career of the employees should be taken into account in order to take appropriate measures or enforce restrictions. The boundary conditions of the work should also be precisely recorded here so that the maximum working height or also the stabiliser width can be restricted under given circumstances (high wind force, high age of the employees, wet surfaces, low weight of persons). The use of alternative materials on the ladder head and larger contact surfaces could also ensure higher static friction and prevent the ladder from slipping away.

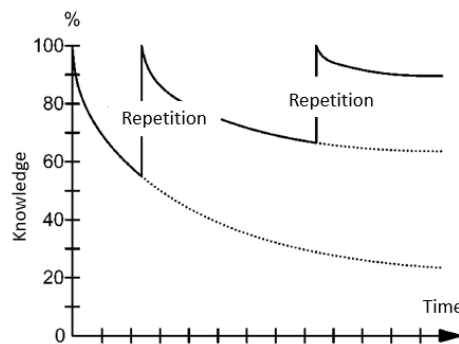

Figure 43: Forgetting curve after Ebbinghaus ⁶⁵

When training or safety instructions are given, the risks associated with the use of a ladder must be repeated in order to reduce dangers. Whenever possible, it is reasonable to change to other work aids.

⁶⁵ Galliker 2007, pp. 209–213.

6.2 Analysis of the results subject B

The examined screw joints are connected with drive-in nuts on the back of the wood. The distance of the screw head to the nut or the required shank length of the screw to be inserted into the drive-in nut is determined by the thickness of the wood. In this case, the wood thickness is approximately 2 cm. The predominant type of connection can be seen in Figure 46. The shank in which the screw is inserted through the wood has no direct contact with the screw.



Figure 44: Example of a screw connection of a drive-in nut in wood⁶⁶

Already at the beginning of the test set-up, the different release torques between the screws mounted by the manufacturer and the screws fastened by the manufacturer were noticeable. Taking the test results into account, it could be assumed that the screw connections were either poorly tightened or pre-assembled under different boundary conditions (temperature and humidity). This means that the moisture content of the wooden ladder at the time the bolts were first tightened was not the same as when they arrived at the test site. It suggests that the moisture content of the wood was higher when it was pre-assembled at the factory and that the wood shrinkage was afterwards. Otherwise, the low triggering moments cannot be explained. As already noted, the moisture content of the air and ultimately the associated moisture content of the wood has significant effects on swelling and shrinkage. The screws are tangential to the wood fibre and therefore in the most favourable position to be affected by the swelling and shrinkage of the wood. It can be assumed that the moisture content of the wood has decreased during storage and transport to the test site, causing the wood to shrink. This has reduced the depth of the wood drill hole, resulting in a lower contact pressure of the screw head on the wood, which was accompanied by a loss of frictional force and a consequently lower release torque. The air humidity and thus also the moisture content in the wood had an influence on the release torque of the screws. The wood swells and shrinks under moisture stress in the tangential direction to such an extent that the integrity of the screw connections can be reduced. This can also have a positive effect on the strength of the joints if the moisture content in the wood increases. Up to a moisture content of 30%, the wood swells, which increases the contact pressure of the bolt head and nut. This also increases the shaft friction forces of the screw and nut thread.

⁶⁶ baubeschlagshop.de 2022.

After completion of the test cycles, no failure or loosening induced by the strong temperature fluctuations could be detected. On the contrary, the release torques increased, contrary to expectations. Since the first test cycle was started at a temperature of 50°C and a humidity of 80%, it can be assumed that the wood absorbed the additional humidity. This is also supported by the fact that the relative humidity in the climate chamber in later cycle phases settled at a maximum temperature of 50°C around 51% and at the lowest temperature of -10°C around 19.4%. Due to the high temperature fluctuations, it can also be assumed that the metal screws, especially the shaft length of the screws, were subject to elastic temperature deformations. However, since the ladder was removed from the climate chamber after the test and stored in an acclimatised state at about 20°C room temperature, this behaviour could not be observed. At this point, however, it should be pointed out that under real conditions there can also be a constant high temperature stress over a longer period of time, which in turn has an influence on the interaction of the screw shaft length and the material depth of the wood. Since in this case there are both high humidity and a high temperature, the deformations of the screw may be slightly negated by the swelling of the wood.

Contrary to expectations, the tests did not reveal the most unfavourable conditions. On the contrary, the cross-check was confirmed. By starting the test cycle at 80% humidity, additional moisture was introduced into the wood. At -10°C, a humidity of 19.4% at 50°C of 51% was found. Since the chamber is closed, it can be assumed that the wood has absorbed moisture. The influence of temperature and especially humidity can be confirmed. Under the given conditions, the behaviour of the wood had a significant influence on the release torque of the bolted joints. A combination of low humidity and high temperatures can be assumed to result in the most unfavourable load case combination. This load combination would increase the loosening of the screws.

The decisive factor for a complete loosening of the bolted connection is therefore also the time and the boundary conditions under which the loft ladder is pre-assembled. If other environmental effects such as storage and transport are added, the connections can loosen in the worst case. The fact that the release torque at the time of the test was about 0.5 Nm is very alarming. Under normal circumstances, without a test cycle, these connections could have loosened without retightening. In addition, the screws fixed by the manufacturer were used in particular on the joints and load-bearing parts. In addition to the initial findings obtained during the tests, further correlations and starting points were identified. In order to determine the exact shrinkage and expansion coefficients of the wood and the screw shafts, further investigations are necessary, for example with the help of DKMS measurement technology.

6.2.1 Recommendation

The results show that there is a considerable safety risk in the case of the tested loft ladder if the manufacturer's pre-assembled screw connections are not tightened again. The most obvious solution would therefore be to include a note in the assembly instructions to check the existing connections and tighten them by hand if necessary. However, as it has been proven that unfavourable boundary conditions can occur that accelerate the loosening of the screw

connections, further measures can be taken to maintain the function and safety of the components. These measures include securing against loosening, automatic loosening and loss.⁶⁷

One possibility is to use safety elements such as spring washers, serrated and toothed washers, disc springs or tension washers. Another possibility is to use screws with lock-serrated head contact surfaces. Thread-forming screws can also provide a secure connection because there is no flank play. Adhesive is another way to secure the position of the screws. Adhesives can be applied from the bottle during assembly or pre-coated screw threads can be used.⁶⁸

An extension of the test procedures by a Junkertest (vibration test) can check the reliability of the connecting and securing tools. Likewise, especially with old, existing loft stair systems, the danger remains high. Therefore, a maintenance cycle or a corresponding seal on the staircase could give an indication of the condition and lead to increased caution. In this context, an inclusion of loft ladders in the EU Construction Products Regulation would also make sense, as loft stairs are firmly connected to the building and usually remain in place throughout the life cycle of the building. Maintenance could also be incorporated into the additional services of a chimney sweeps. Alternatively, the exclusive installation of the loft ladder systems as a safety-relevant component by specialist companies is possible.

⁶⁷ Wiegand et al. 2007.

⁶⁸ Wiegand et al. 2007, pp. 385–405.

Appendix

1: Testing protocols window cleaning ladders

Bibliography

Publication bibliography

Ausschuss für Betriebssicherheit (2018): Technische Regeln für Betriebssicherheit. TRBS 2121-2. Edited by Bundesanstalt für Arbeitsschutz und Arbeitsmedizin. Bundesanstalt für Arbeitsschutz und Arbeitsmedizin.

baua.de (2022): baua.de, updated on 11/4/2022, checked on 11/4/2022.

baubeschlagshop.de (2022): Einschlagmuttern TS. Available online at <https://www.baubeschlagshop.de/schrauben-co/muttern-und-scheiben/einschlagmuttern-ts/index.php>, updated on 11/4/2022, checked on 11/4/2022.

BGBau (2022): Absturzunfälle. BGBau, updated on 11/4/2022, checked on 11/4/2022.

contorion.de (2022): Contorion: digitaler Fachhändler für Handwerk und Industrie. Available online at <https://www.contorion.de/p/hymer-glasreinigerleiter-4-teiliger-satz-23-sprossen-96818109?q=glasreinigerleiter>, updated on 11/4/2022, checked on 11/4/2022.

Deutsche Gesetzliche Unfallversicherung e.V. (2010-2020): Arbeitsunfallgeschehen. Edited by Deutsche Gesetzliche Unfallversicherung (DGUV). Referat Statistik. Berlin. Available online at <https://publikationen.dguv.de/zahlen-fakten/schwerpunkt-themen/4271/arbeitsunfallgeschehen-2020>.

Deutsche Gesetzliche Unfallversicherung e.V. (2010): Arbeitsunfallgeschehen. Edited by Deutsche Gesetzliche Unfallversicherung (DGUV). Referat Statistik. Berlin. Available online at <https://publikationen.dguv.de/zahlen-fakten/schwerpunkt-themen/4271/arbeitsunfallgeschehen-2020>.

Deutsche Gesetzliche Unfallversicherung e.V. (2020): Arbeitsunfallgeschehen. Edited by Deutsche Gesetzliche Unfallversicherung (DGUV). Referat Statistik. Berlin. Available online at <https://publikationen.dguv.de/zahlen-fakten/schwerpunkt-themen/4271/arbeitsunfallgeschehen-2020>.

DGUV forum (2020): Kennziffern der Deutschen Gesetzlichen Unfallversicherung 2019. Available online at <https://forum.dguv.de/ausgabe/7-2020/artikel/kennziffern-der-deutschen-gesetzlichen-unfallversicherung-2019>, updated on 9/18/2020, checked on 11/4/2022.

Digi-Key Electronics (2022): 9901 | Digi-Key Electronics. Available online at https://www.digikey.de/de/products/detail/keystone-electronics/9901/317322?utm_adgroup=Screws%2C%20Bolts&utm_source=google&utm_medium=cpc&utm_campaign=Shopping_Product_Hardware%2C%20Fasteners%2C%20Accessories&utm_term=&productid=317322&gclid=CjwKCAjw8JKbBhBYEiwAs3sxN0jL9VnjSgvvnTfdH6ictq_Fkip0ddH9le_z5XVnM4bzPhJ5JD9MEROc-noQAvD_BwE, updated on 11/4/2022, checked on 11/4/2022.

Dipl.-Ing. Hendrikje Rahming (2018): Die neue TRBS 2121-2 „Gefährdung von Beschäftigten durch Absturz bei der Verwendung von Leitern“. Edited by DGUV. DGUV. Berlin. Available online at https://www.dguv.de/medien/fb-bauwesen/dokumente/bauportal_02_19_trbs2121_leitern.pdf, updated on 7/28/2022, checked on 7/28/2022.

Dobrinski, Paul; Krakau, Gunter; Vogel, Anselm (2010): Physik für Ingenieure. 12., aktualisierte Aufl. Wiesbaden: Vieweg + Teubner (Studium).

ETUC: ETUC report on accidents with loft ladders used by chimney sweeps,. June 2021, for internal use in CEN/TC 93 WG 9, checked on 8/13/2022.

etuc.org (2022): <https://www.etuc.org/en/etuc-stand-project>, updated on 8/13/2022, checked on 8/13/2022.

European Statistics on Accidents at Work (ESAW) - Summary methodology - 2013 edition (2022). Available online at <https://ec.europa.eu/eurostat/web/products-manuals-and-guidelines/-/ks-ra-12-102>, updated on 11/2/2022, checked on 11/2/2022.

- Galliker, Mark (2007): Meilensteine der Psychologie. Die Geschichte der Psychologie nach Personen, Werk und Wirkung. s.l.: Alfred Kröner Verlag. Available online at <http://gbv.eblib.com/patron/FullRecord.aspx?p=4341635>.
- Główny Urząd Statystyczny (2011-2019): Wypadki przy pracy - Accidents at work. Edited by Urząd Statystyczny w Gdańsku. Warszawa, Gdańsk.
- Główny Urząd Statystyczny (2020): Wypadki przy pracy - Accidents at work. Edited by Urząd Statystyczny w Gdańsku. Warszawa, Gdańsk.
- Health and Safety Executive Britain (2017-2021): Construction statistics in Great Britain. Edited by Health and Safety Executive Britain. Health and Safety Executive Britain.
- Hering, Ekbert; Martin, Rolf; Stohrer, Martin (2004): Physik für Ingenieure. 9. Auflage. Berlin, Heidelberg: Springer Berlin Heidelberg (Springer-Lehrbuch).
- Koenders, Eddie; Weise, Kira; Vogt, Oliver (2020): Werkstoffe im Bauwesen. Einführung für Bauingenieure und Architekten. Wiesbaden, Heidelberg: Springer Vieweg (Lehrbuch).
- Koordinationsgruppe für die Statistik der Unfallversicherung UVG (2010-2021): Unfallstatistik UVG. Edited by Koordinationsgruppe für die Statistik der Unfallversicherung UVG. SUVA.
- Koordinationsgruppe für die Statistik der Unfallversicherung UVG (2015-2019): Unfallstatistik UVG. Edited by Koordinationsgruppe für die Statistik der Unfallversicherung UVG. SUVA.
- DIN EN 131-1, 11/1/2019: Ladders - Part 1: Terms, types, functional sizes; German version EN 131-1:2015+A1:2019.
- DIN EN 131-2, 4/1/2017: Ladders - Part 2: Anforderungen, Prüfung, Kennzeichnung; Deutsche Fassung EN 131-2:2010+A2:2017.
- DIN EN 14975, 12/1/2010: Loft ladders – Requirements, marking and testing; German version EN 14975:2006+A1:2010.
- Statistics | Eurostat (2022a). Available online at https://ec.europa.eu/eurostat/databrowser/view/hsw_n2_04/default/table, updated on 11/2/2022, checked on 11/2/2022.
- Statistics | Eurostat (2022b). Available online at https://ec.europa.eu/eurostat/databrowser/view/hsw_n2_04/default/table, updated on 11/2/2022, checked on 11/2/2022.
- Statistics | Eurostat (2022c). Available online at https://ec.europa.eu/eurostat/databrowser/view/hsw_n2_04/default/map, updated on 11/2/2022, checked on 11/2/2022.
- Statistics | Eurostat (2022d). Available online at https://ec.europa.eu/eurostat/databrowser/view/hsw_n2_02/default/map?lang=en, updated on 11/4/2022, checked on 11/4/2022.
- Statistics | Eurostat (2022e). Available online at https://ec.europa.eu/eurostat/databrowser/view/hsw_n2_02/default/table, updated on 11/4/2022, checked on 11/4/2022.
- steigtechnik.de (2022): Sprossen-Seilzugleiter 2-teilig ohne Traverse, 2x14 Sprossen | MUNK Group. Available online at https://www.steigtechnik.de/de/Produkte/Sprossen-Seilzugleiter-2-teilig-ohne-Traverse_p162138?type=69173, updated on 11/4/2022, checked on 11/4/2022.
- Wetzell, Otto W.; Krings, Wolfgang (1972): Technische Mechanik für Bauingenieure: Springer.
- Wiegand, Heinrich; Kloos, Karl H.; Thomala, Wolfgang; Kloos, Karl-Heinz (Eds.) (2007): Schraubenverbindungen - Selbsttätiges Lösen und Sichern von Schraubenverbindungen. Grundlagen, Berechnung, Eigenschaften, Handhabung. 4., völlig Neubearb. und erw. Aufl. Berlin, Heidelberg, New York, London, Paris, Tokyo: Springer (Konstruktionsbücher, 5).